

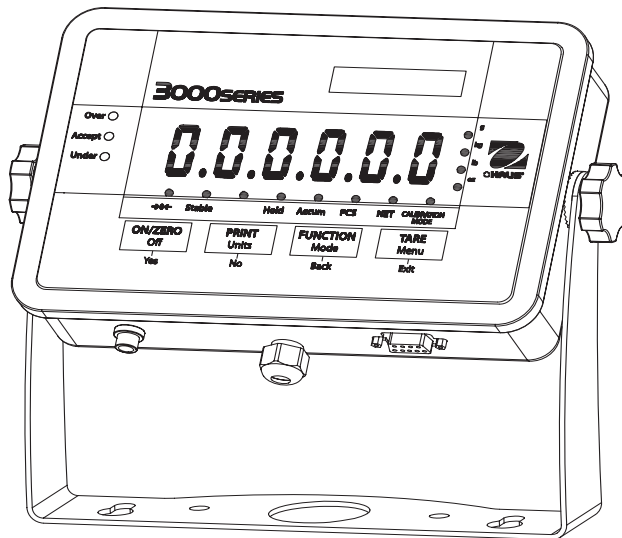

3000 Series Indicators

Instruction Manual



T32ME Indicator

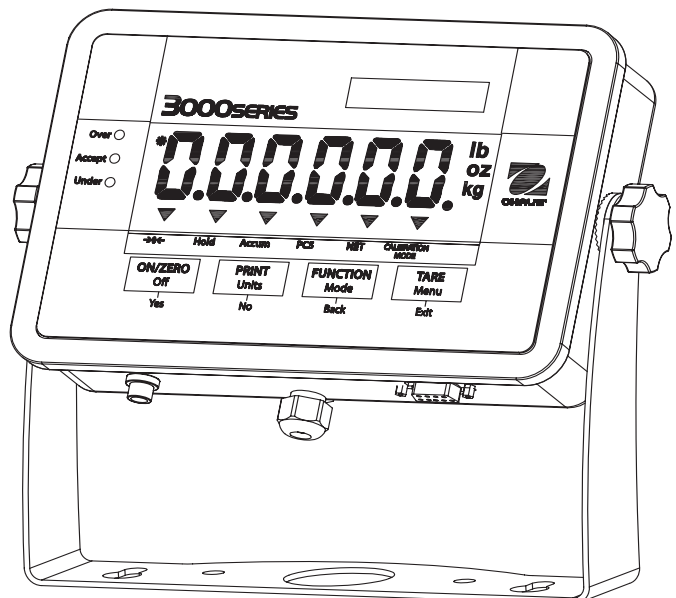

T32MC Indicator

TABLE OF CONTENTS

1. INTRODUCTION.....	EN-4
1.1 Safety Precautions	EN-4
1.2 Overview of Parts and Controls	EN-5
1.3 Control Functions.....	EN-9
2. INSTALLATION	EN-10
2.1 Unpacking	EN-10
2.2 External Connections.....	EN-10
2.2.1 RS232 Interface Cable to T32M.....	EN-10
2.2.2 AC Power to T32M	EN-10
2.2.3 Mounting Bracket to T32M.....	EN-10
2.3 Internal Connections.....	EN-11
2.3.1 Opening the Housing.....	EN-11
2.3.2 Scale Base to T32M	EN-11
2.4 Mounting Bracket	EN-12
3. SETTINGS.....	EN-13
3.1 Menu Structure	EN-13
3.2 Menu Navigation	EN-14
3.3 Calibration Menu	EN-14
3.3.1 Span Calibration.....	EN-15
3.3.2 Linearity Calibration	EN-15
3.3.3 Geographical Adjustment Factor	EN-16
3.3.4 End Calibration.....	EN-16
3.4 Setup Menu.....	EN-18
3.4.1 Reset.....	EN-18
3.4.2 Legal for trade	EN-18
3.4.3 Calibration Unit.....	EN-18
3.4.4 Capacity	EN-18
3.4.5 Graduation.....	EN-20
3.4.6 Power On Unit	EN-20
3.4.7 Zero Range	EN-20
3.4.8 Retain Zero Data.....	EN-20
3.4.9 End Setup	EN-20

TABLE OF CONTENTS (Cont.)

3.5	Readout Menu	EN-21
3.5.1	Reset	EN-21
3.5.2	Stable	EN-21
3.5.3	Filter	EN-21
3.5.4	Auto-Zero Tracking	EN-21
3.5.5	Sleep (T32ME)	EN-22
3.5.6	Light (T32ME)	EN-22
3.5.7	Backlight (T32MC)	EN-22
3.5.8	Auto Off Timer	EN-22
3.5.9	Expand Mode (For testing only)	EN-22
3.5.10	End Readout	EN-22
3.6	Mode Menu	EN-23
3.6.1	Reset	EN-23
3.6.2	Parts Counting Mode	EN-23
3.6.3	Display Hold Mode	EN-23
3.6.4	Checkweigh Mode	EN-23
3.6.5	Totalize Mode	EN-23
3.6.6	End Mode	EN-23
3.7	Unit Menu	EN-24
3.7.1	Reset	EN-24
3.7.2	Kilogram Unit	EN-24
3.7.3	Pound Unit	EN-24
3.7.4	Gram Unit	EN-24
3.7.5	Ounce Unit	EN-24
3.7.6	Pound Ounce Unit	EN-24
3.7.7	End Unit	EN-25
3.8	Print Menu	EN-25
3.8.1	Reset	EN-25
3.8.2	Baud	EN-25
3.8.3	Parity	EN-25
3.8.4	Stop Bit	EN-26
3.8.5	Handshake	EN-26
3.8.6	Print Stable Data Only	EN-26
3.8.7	Auto Print	EN-26
3.8.8	Content	EN-26
3.8.9	End Print	EN-26
3.9	Lock Menu	EN-27
3.9.1	Reset	EN-27
3.9.2	Lock Calibration	EN-27
3.9.3	Lock Setup	EN-27
3.9.4	Lock Readout	EN-27
3.9.5	Lock Mode	EN-27
3.9.6	Lock Unit	EN-27
3.9.7	Lock Print	EN-28
3.9.8	End Lock	EN-28

TABLE OF CONTENTS (Cont.)

3.10 End Menu	EN-28
3.11 Security Switch	EN-28
4. OPERATION	EN-28
4.1 Turning Indicator On/Off	EN-28
4.2 Zero Operation	EN-28
4.3 Manual Tare	EN-28
4.4 Changing Units of Measure	EN-29
4.5 Printing Data	EN-29
4.6 Application Modes	EN-29
4.6.1 Weighing	EN-29
4.6.2 Parts Counting	EN-29
4.6.3 Display-Hold	EN-31
4.6.4 Check Weighing	EN-31
4.6.5 Totalize	EN-33
5. SERIAL COMMUNICATION	EN-34
5.1 Interface Commands	EN-34
5.2 Output Format	EN-35
6. LEGAL FOR TRADE	EN-36
6.1 Settings	EN-36
6.2 Verification	EN-36
6.3 Sealing	EN-36
6.3.1 Physical Seals	EN-36
6.3.2 Audit Trail Seal	EN-37
7. MAINTENANCE	EN-38
7.1 Model T32M Cleaning	EN-38
7.2 Troubleshooting	EN-38
7.4 Service Information	EN-38
8. TECHNICAL DATA	EN-40
8.1 Specifications	EN-40
8.2 Accessories and Options	EN-41
8.3 Drawings and Dimensions	EN-41
8.4 Compliance	EN-42

1. INTRODUCTION

This manual contains installation, operation and maintenance instructions for the T32M Indicators. Please read this manual completely before installation and operation.

1.1 Safety Precautions



For safe and dependable operation of this equipment, please comply with the following safety precautions:

- Verify that the input voltage range printed on the data label matches the local AC power to be used.
- Make sure that the power cord does not pose a potential obstacle or tripping hazard.
- Use only approved accessories and peripherals.
- Operate the equipment only under ambient conditions specified in these instructions.
- Disconnect the equipment from the power supply before cleaning.
- Do not operate the equipment in hazardous or unstable environments.
- Do not immerse the equipment in water or other liquids.
- Service should only be performed by authorized personnel.

1.2 Overview of Parts and Controls

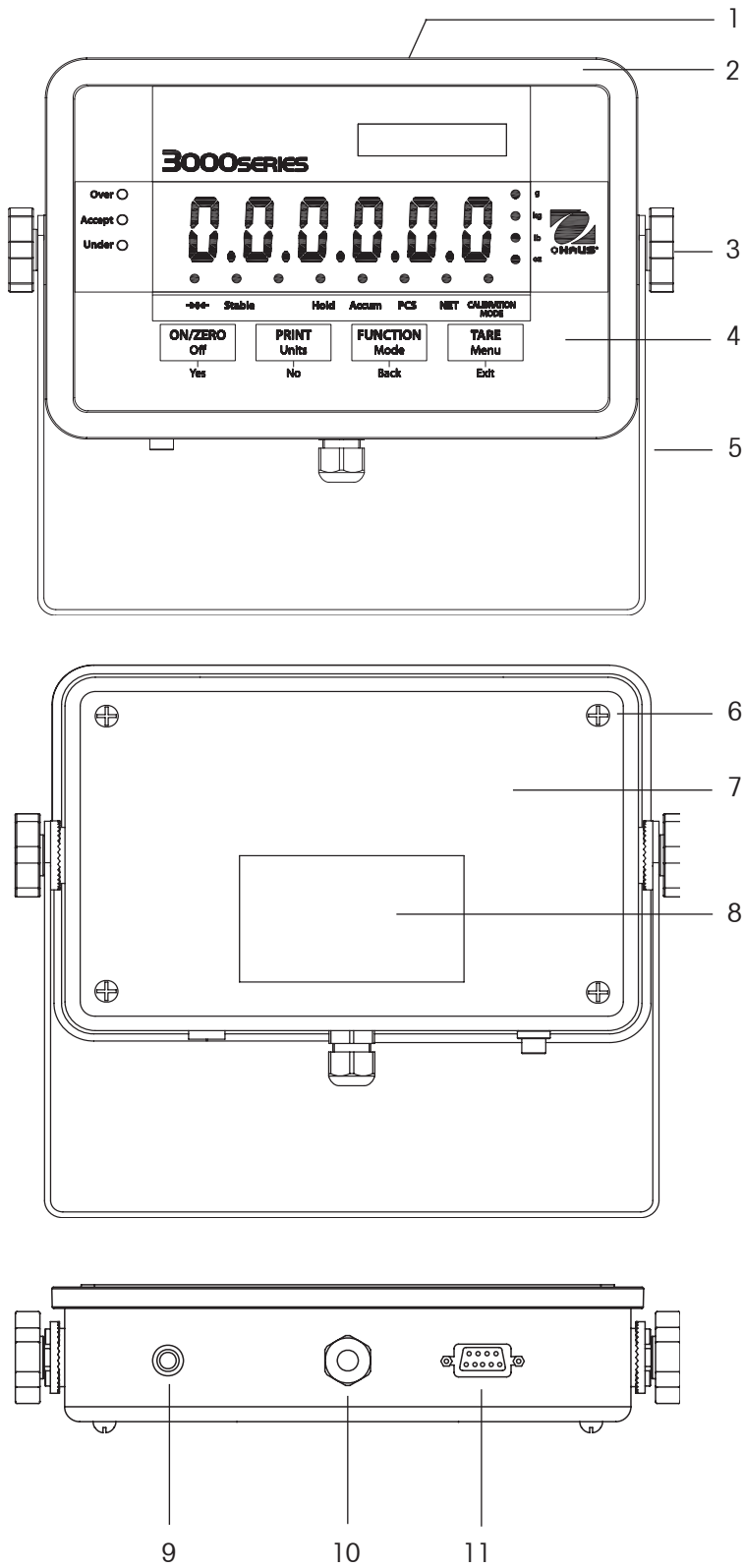

TABLE 1-1. T32MC/T32ME PARTS.

Item	Description
1	Data Label
2	Front Housing
3	Adjusting Knob (2)
4	Control Panel
5	Mounting Bracket
6	Screw (4)
7	Rear Housing
8	Data Label
9	Power receptacle
10	Strain Relief for Load Cell Cable
11	RS232 Connector

Figure 1-1. T32MC/T32ME Indicator.

1.2 Overview of Parts and Controls (Cont.)

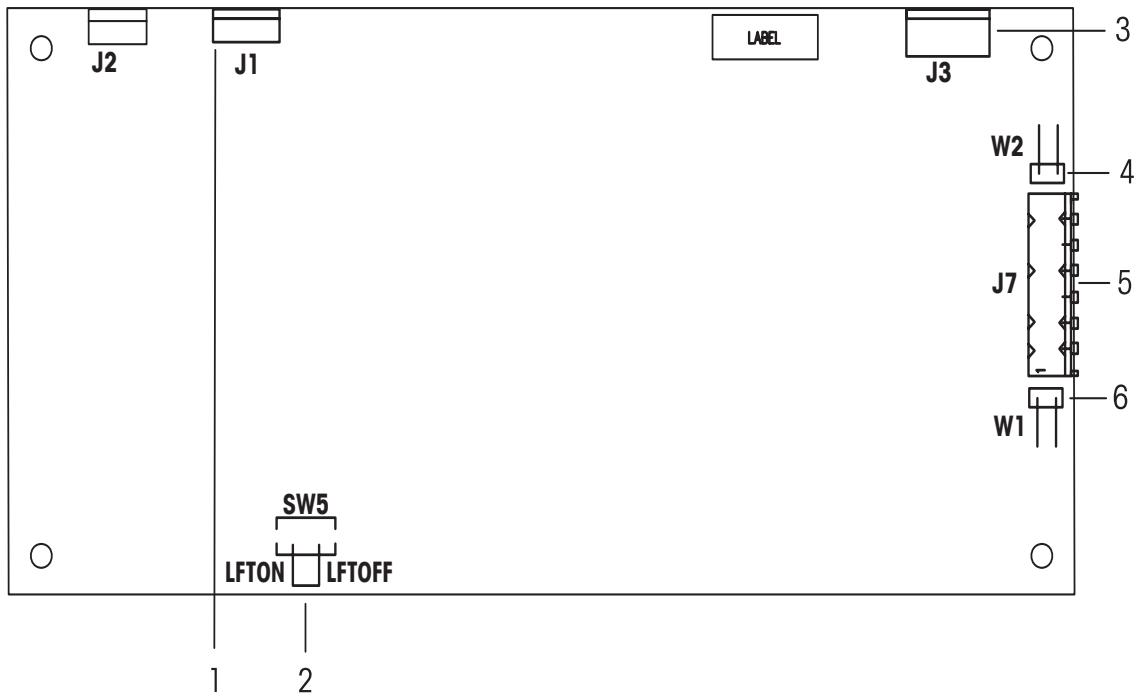

Figure 1-2. Main PC Board.

TABLE 1-2. MAIN PC BOARD.

Item	Description
1	Line Power Input J1
2	LFT On / Off Switch
3	RS232 Connector J3
4	Sense Jumper W2
5	Load Cell Terminal Block J7
6	Sense Jumper W1

1.2 Overview of Parts and Controls (Cont.)

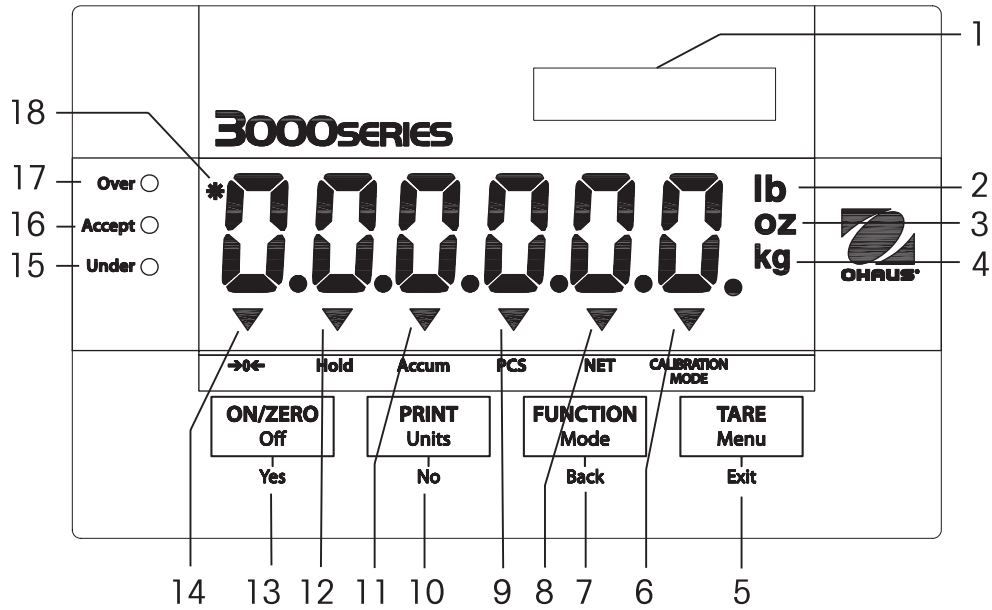

Figure 1-3. Controls and Indicators T32MC

TABLE 1-3. CONTROL PANEL.

No.	Designation
1	Capacity Label Window
2	Pound indicator
3	Ounce indicator
4	Kilogram, gram indicator
5	TARE <i>Menu</i> button
6	CALIBRATION MODE indicator
7	FUNCTION <i>Mode</i> button
8	NET indicator
9	PCS indicator
10	PRINT <i>Units</i> button
11	Accumulation indicator
12	Hold indicator
13	ON/ZERO <i>Off</i> button
14	Center of Zero indicator
15	Under LED
16	Accept LED
17	Over LED
18	Stable weight indicator

1.2 Overview of Parts and Controls (Cont.)

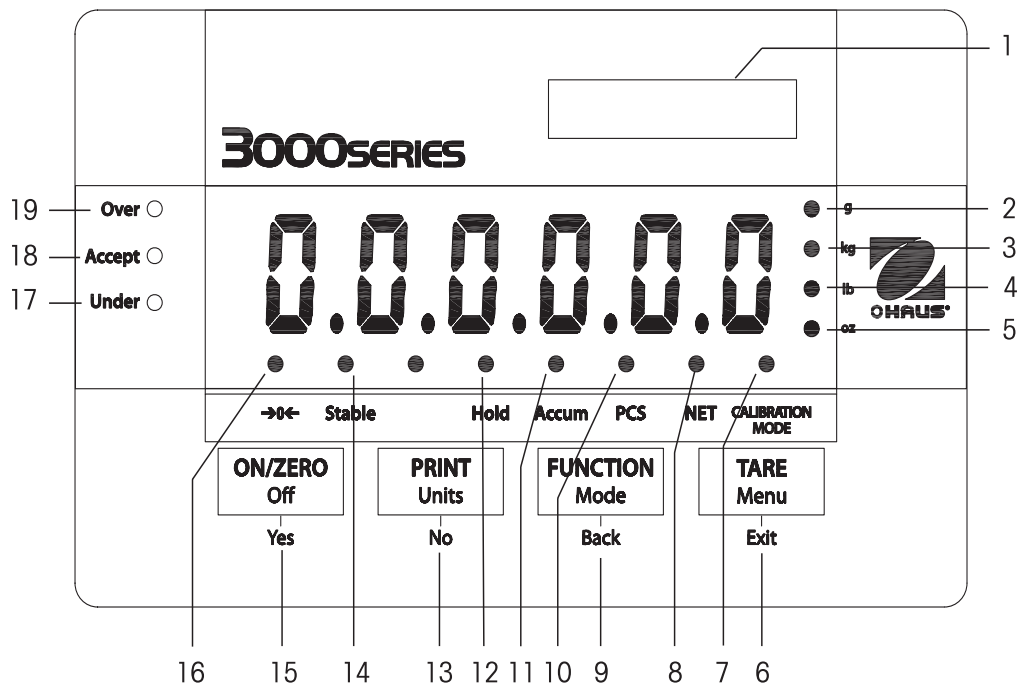

Figure 1-4. Controls and Indicators T32ME.

TABLE 1-4. CONTROL PANEL.

No.	Designation
1	Capacity Label Window
2	Gram indicator
3	Kilogram indicator
4	Pound indicator
5	Ounce indicator
6	TARE Menu button
7	CALIBRATION MODE indicator
8	NET indicator
9	FUNCTION Mode button
10	PCS indicator
11	Accumulation indicator
12	Hold indicator
13	PRINT Units button
14	Stable weight indicator
15	ON/ZERO Off button
16	Center of Zero indicator
17	Under LED
18	Accept LED
19	Over LED

1.3 Control Functions

TABLE 1-5. CONTROL FUNCTIONS.

Button	<div style="border: 1px solid black; padding: 5px; text-align: center;"> ON/ZERO Off Yes </div>	<div style="border: 1px solid black; padding: 5px; text-align: center;"> PRINT Units No </div>	<div style="border: 1px solid black; padding: 5px; text-align: center;"> FUNCTION Mode Back </div>	<div style="border: 1px solid black; padding: 5px; text-align: center;"> TARE Menu Exit </div>
Primary Function (Short Press)	<p>ON/ZERO</p> <p>If Indicator is On, sets zero.</p>	<p>PRINT</p> <p>Sends the current value to the COM port if AUTOPRINT is set to Off.</p>	<p>FUNCTION</p> <p>Initiates an application mode.</p>	<p>TARE</p> <p>Performs a tare operation.</p>
Secondary Function (Long Press)	<p>Off</p> <p>Turns the Indicator on or off.</p>	<p>Units</p> <p>Changes the weighing Unit.</p>	<p>Mode</p> <p>Allows changing the application mode.</p> <p>Press and hold allows scrolling through modes.</p>	<p>Menu</p> <p>Enter the User menu.</p> <p>View the Audit Trail event counters (extended press)</p>
Menu Function (Short Press)	<p>Yes</p> <p>Accepts the current setting on the display.</p>	<p>No</p> <p>Advances to the next menu or menu item.</p> <p>Rejects the current setting on the display and advances to the next available setting.</p> <p>Increments the value.</p>	<p>Back</p> <p>Moves Back to previous menu item.</p> <p>Decrements the value.</p>	<p>Exit</p> <p>Exits the User menu.</p> <p>Aborts the calibration in progress.</p>

2. INSTALLATION

2.1 Unpacking

Unpack the following items:

- Indicator
- AC Adapter
- Mounting Bracket
- Knobs (2)
- Capacity Label Sheet
- Instruction Manual CD
- Warranty Card
- LFT sealing Kit

2.2 External Connections

2.2.1 RS232 interface Cable to the indicator

Connect the optional RS232 cable to the RS232 connector (Figure 1-1, item 11).

Pin	Connection
1	N/C
2	TXD
3	RXD
4	N/C
5	GND
6	N/C
7	N/C
8	N/C
9	N/C

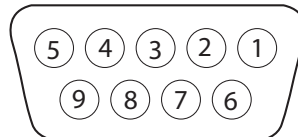

Figure 2-1. RS232 Pins.

2.2.2 AC Power

Connect the AC Adapter to the power receptacle (Figure 1-1, item 9), then plug the AC Adapter into an electrical outlet.

2.2.3 Mounting Bracket to the Indicator

Align the mounting bracket over the threaded holes in the side of the indicator and install the knobs. Adjust the indicator to the desired angle and tighten the knobs.

2.3 Internal Connections

Some connections require the housing to be opened.

2.3.1 Opening the Housing



CAUTION: ELECTRICAL SHOCK HAZARD. REMOVE ALL POWER CONNECTIONS TO THE INDICATOR BEFORE SERVICING OR MAKING INTERNAL CONNECTIONS. THE HOUSING SHOULD ONLY BE OPENED BY AUTHORIZED AND QUALIFIED PERSONNEL, SUCH AS AN ELECTRICAL TECHNICIAN.

Remove the four Phillips head screws from the rear housing.
 Open the housing being careful not to disturb the internal connections.
 Once all connections are made, reattach the front housing.

2.3.2 Scale Base to the indicator

Pass the load cell cable through the strain relief (Figure 1-1, item 10) and attach it to terminal block J7 (Figure 1-2, item 5).

Pin	Connection
J7-1	+EXCITATION
J7-2	+SENSE
J7-3	+SIGNAL
J7-4	GROUND
J7-5	-SIGNAL
J7-6	-SENSE
J7-7	-EXCITATION

Jumper Connections

For a 4-wire load cell with no sense wires: Jumpers W1 and W2 must be shorted.
 For a 6-wire load cell that includes sense wires, see Figure 2-2. Jumpers W1 and W2 must be opened.
 For load cells with an extra ground shield wire: Connect the shield to the center position (GND) of J7.

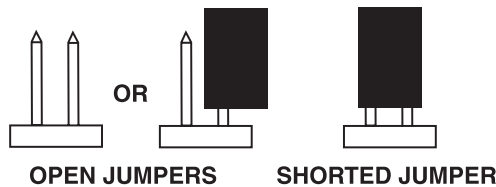

Figure 2-2. Jumper Connections.

After wiring is completed and jumpers are in place, replace the indicator housing screws. Make sure the strain relief is properly tightened.

2.4 Mounting Bracket

Attach the bracket to a wall or table using fasteners (not supplied) that are appropriate for the type of mounting surface. The bracket will accommodate up to 6 mm (1/4") diameter screws. Locate the mounting holes as shown in Figure 2-3.

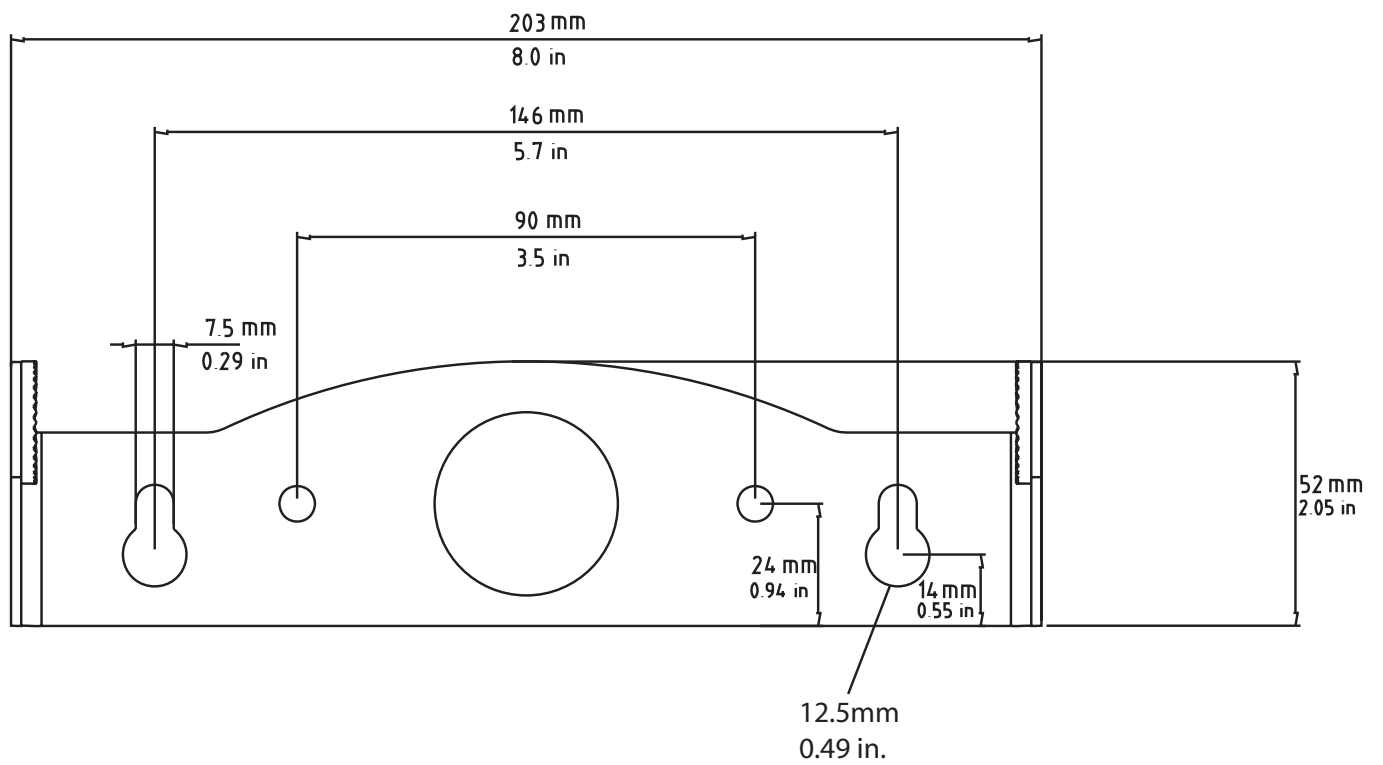

Figure 2-3. Mounting Bracket Dimensions.

3 SETTINGS

3.1 Menu Structure

TABLE 3-1. MENU STRUCTURE.

CALIBRATION	→ SETUP	→ READOUT	→ MODE	→ UNIT	→ PRINT	→ LOCK	→ END
↳ SPAN	↳ RESET	↳ RESET	↳ RESET	↳ RESET	↳ RESET	↳ RESET	
↳ LINEARITY	↳ NO	↳ NO	↳ NO	↳ NO	↳ NO	↳ NO	
↳ GEO	↳ YES	↳ YES	↳ YES	↳ YES	↳ YES	↳ YES	
↳ 0...31	↳ LEGAL FOR TRADE	↳ STABILITY	↳ COUNT	↳ KILOGRAM	↳ BAUD	↳ LOCK CAL	
↳ END CAL	↳ OFF	↳ 0.5d	↳ OFF	↳ OFF	↳ 300, ...19200	↳ OFF	
	↳ ON	↳ 1d	↳ ON	↳ ON	↳ PARITY	↳ ON	
	↳ CALIBRATION UNIT	↳ 2d	↳ HOLD	↳ POUND	↳ 7 EVEN	↳ LOCK SETUP	
	↳ KILOGRAM	↳ 3d	↳ OFF	↳ OFF	↳ 7 ODD	↳ OFF	
	↳ POUND	↳ FILTER	↳ ON	↳ ON	↳ 7 NONE	↳ ON	
	↳ CAPACITY	↳ LOW	↳ CHECK WEIGH	↳ GRAM	↳ 8 NONE	↳ LOCK READOUT	
	↳ 5...20000	↳ MEDIUM	↳ OFF	↳ OFF	↳ STOP	↳ OFF	
	↳ GRADUATION	↳ HI	↳ ON	↳ ON	↳ 1	↳ ON	
	↳ 0.0005...20	↳ AUTO ZERO	↳ TOTALIZE	↳ OUNCE	↳ 2	↳ LOCK MODE	
	↳ POWER ON UNIT	↳ OFF	↳ OFF	↳ OFF	↳ HANDSHAKE	↳ OFF	
	↳ AUTO	↳ 0.5d	↳ ON	↳ ON	↳ OFF	↳ ON	
	↳ GRAM	↳ 1d	↳ END MODE	↳ POUND OUNCE	↳ XON-XOFF	↳ LOCK UNIT	
	↳ KILOGRAM	↳ 3d		↳ OFF	↳ STABLE ONLY	↳ OFF	
	↳ POUND	↳ SLEEP (T32ME)		↳ ON	↳ OFF	↳ ON	
	↳ OUNCE	↳ OFF		↳ END UNIT	↳ ON	↳ LOCK PRINT	
	↳ ZERO RANGE	↳ ON			↳ AUTO PRINT	↳ OFF	
	↳ 2%	↳ LIGHT (T32ME)			↳ OFF	↳ ON	
	↳ 100%	↳ LOW			↳ ON STABLE	↳ END MENU LOCK	
	↳ RETAIN ZERO DATA	↳ MEDIUM			↳ INTERVAL		
	↳ OFF	↳ HI			↳ 1...3600		
	↳ ON	↳ BACKLIGHT(T32MC)			↳ CONTINUOUS		
	↳ END SETUP	↳ AUTO			↳ CONTENT		
		↳ ON			↳ GROSS		
		↳ OFF			↳ NET		
		↳ AUTO OFF			↳ TARE		
		↳ OFF			↳ UNIT		
		↳ SET 1			↳ END PRINT		
		↳ SET 2					
		↳ SET 5					
		↳ EXPAND MODE					
		↳ OFF					
		↳ ON					
		↳ END READOUT					

3.2 Menu Navigation

TO ENTER THE MENU MODE

Press and hold the Menu button until MENU appears on the display. The first upper level menu appears on the display.



Summary of button navigation functions in menu mode:

- Yes** Allows entry into the displayed menu.
Accepts the displayed setting and advances to the next menu item.
- No** Skips by the displayed menu.
Rejects the displayed setting or menu item and advances to the next available item.
- Back** Moves backwards through the upper and middle level menus.
Backs out of a list of selectable items to the previous middle level menu.
- Exit** Exits from menu directly to the active weighing mode.

For Checkweigh under and over targets setup, the current setting is displayed with all digits flashing. Press the **No** button to begin editing.

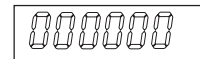

The first digit is displayed flashing.



Press the **No** button to increment the digit or press the **Yes** button to accept the digit and move to the next digit.



Repeat this process for all digits.



Press the **Yes** button when the last digit has been set.



The new setting is displayed with all digits flashing. Press the **Yes** button to accept the setting or press the **No** button to resume editing.

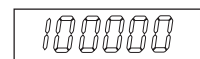

3.3 Calibration Menu

Two calibration processes are available: Span Calibration and Linearity Calibration.



NOTES:

1. Make sure that appropriate calibration masses are available before beginning calibration.
2. Make sure that the scale base is level and stable during the entire calibration process.
3. Calibration is unavailable with LFT set to On.
4. Allow the Indicator to warm up for approximately 5 minutes after stabilizing to room temperature.
5. To abort calibration, press the **Exit** button anytime during the calibration process.

Span	Perform
Linearity	Perform
Geographic	
Adjustment	0...31
End Calibration	Exit CALIBRATION menu

3.3.1 Span Calibration



Span Calibration uses two points to adjust the scale. The first point is the zero value where there is no weight on the scale. The second point is the Span value where a calibration mass is placed on the scale.

When SPAN is displayed, press the **Yes** button to access the Span Calibration menu item.

The display flashes 0. With no weight on the scale, press the **Yes** button to establish the zero point.



The display shows --C-- while the zero point is established.



The display flashes the span calibration point. Place the specified weight on the scale and press the **Yes** button.

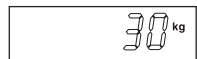

To choose a different span point, repeatedly press the **No** button to increment the selections or press the **Back** button to decrement the selections. Refer to Table 3-3 for available span points. When the desired value is displayed, place the specified weight on the scale and press the **Yes** button.

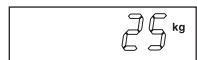

The display shows --C-- while the span point is established.

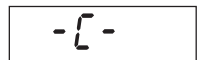

If span calibration was successful, the scale exits to the active weighing mode and displays the actual weight value.

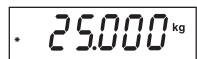

3.3.2 Linearity Calibration



Linearity calibration uses 3 calibration points. The first calibration point is established with no weight on the scale. The second calibration point is established at approximately half capacity. The third calibration point is established at capacity. The Linearity calibration points are fixed and cannot be altered by the user during the calibration procedure. Refer to Table 3-3 for the linearity points.

When LINEAR is displayed, press the **Yes** button to access the Linearity Calibration menu item.

The display flashes 0. With no weight on the scale, press the **Yes** button to establish the zero point.



The display shows --C-- while the zero point is established.

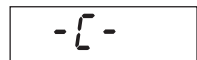

The display flashes the mid calibration point.



Place the specified weight on the scale and press the **Yes** button.

The display shows --C-- while the mid point is established.

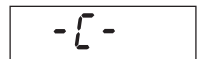

The display flashes the full calibration point.



Place the specified weight on the scale and press the **Yes** button.

The display shows --C-- while the full point is established.

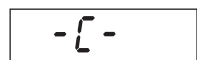

If linearity calibration was successful, the scale exits to the active weighing mode and displays the actual weight value.



3.3.3 Geographical Adjustment Factor

The Geographical Adjustment Factor (GEO) is used to compensate for variations in gravity.

GEO

Settings from 0 to 31 are available. Refer to table 3-2 to determine the GEO factor that corresponds to your location.

0

•
•
•

Note: Changing the GEO Factor alters the calibration. The GEO value was set at the factory and should only be changed by an authorized manufacturer's representative or certified verification personnel.

31

3.3.4 End Calibration

Advance to the next menu.

End

TABLE 3-2. GEOGRAPHICAL ADJUSTMENT VALUES

Latitude		Elevation in meters										
		0	325	650	975	1300	1625	1950	2275	2600	2925	3250
		325	650	975	1300	1625	1950	2275	2600	2925	3250	3575
		Elevation in feet										
		0	1060	2130	3200	4260	5330	6400	7460	8530	9600	10660
		1060	2130	3200	4260	5330	6400	7460	8530	9600	10660	11730
Latitude		GEO value										
0°00'	5°46'	5	4	4	3	3	2	2	1	1	0	0
5°46'	9°52'	5	5	4	4	3	3	2	2	1	1	0
9°52'	12°44'	6	5	5	4	4	3	3	2	2	1	1
12°44'	15°06'	6	6	5	5	4	4	3	3	2	2	1
15°06'	17°10'	7	6	6	5	5	4	4	3	3	2	2
17°10'	19°02'	7	7	6	6	5	5	4	4	3	3	2
19°02'	20°45'	8	7	7	6	6	5	5	4	4	3	3
20°45'	22°22'	8	8	7	7	6	6	5	5	4	4	3
22°22'	23°54'	9	8	8	7	7	6	6	5	5	4	4
23°54'	25°21'	9	9	8	8	7	7	6	6	5	5	4
25°21'	26°45'	10	9	9	8	8	7	7	6	6	5	5
26°45'	28°06'	10	10	9	9	8	8	7	7	6	6	5
28°06'	29°25'	11	10	10	9	9	8	8	7	7	6	6
29°25'	30°41'	11	11	10	10	9	9	8	8	7	7	7
30°41'	31°56'	12	11	11	10	10	9	9	8	8	7	7
31°56'	33°09'	12	12	11	11	10	10	9	9	8	8	7
33°09'	34°21'	13	12	12	11	11	10	10	9	9	8	8
34°21'	35°31'	13	13	12	12	11	11	10	10	9	9	8
35°31'	36°41'	14	13	13	12	12	11	11	10	10	9	9
36°41'	37°50'	14	14	13	13	12	12	11	11	10	10	9
37°50'	38°58'	15	14	14	13	13	12	12	11	11	10	10
38°58'	40°05'	15	15	14	14	13	13	12	12	11	11	10
40°05'	41°12'	16	15	15	14	14	13	13	12	12	11	11
41°12'	42°19'	16	16	15	15	14	14	13	13	12	12	11
42°19'	43°26'	17	16	16	15	15	14	14	13	13	12	12
43°26'	44°32'	17	17	16	16	15	15	14	14	13	13	12
44°32'	45°38'	18	17	17	16	16	15	15	14	14	13	13
45°38'	46°45'	18	18	17	17	16	16	15	15	14	14	13
46°45'	47°51'	19	18	18	17	17	16	16	15	15	14	14
47°51'	48°58'	19	19	18	18	17	17	16	16	15	15	14
48°58'	50°06'	20	19	19	18	18	17	17	16	16	15	15
50°06'	51°13'	20	20	19	19	18	18	17	17	16	16	15
51°13'	52°22'	21	20	20	19	19	18	18	17	17	16	16
52°22'	53°31'	21	21	20	20	19	19	18	18	17	17	16
53°31'	54°41'	22	21	21	20	20	19	19	18	18	17	17
54°41'	55°52'	22	22	21	21	20	20	19	19	18	18	17
55°52'	57°04'	23	22	22	21	21	20	20	19	19	18	18
57°04'	58°17'	23	23	22	22	21	21	20	20	19	19	18
58°17'	59°32'	24	23	23	22	22	21	21	20	20	19	19
59°32'	60°49'	24	24	23	23	22	22	21	21	20	20	19
60°49'	62°09'	25	24	24	23	23	22	22	21	21	20	20
62°09'	63°30'	25	25	24	24	23	23	22	22	21	21	20
63°30'	64°55'	26	25	25	24	24	23	23	22	22	21	21
64°55'	66°24'	26	26	25	25	24	24	23	23	22	22	21
66°24'	67°57'	27	26	26	25	25	24	24	23	23	22	22
67°57'	69°35'	27	27	26	26	25	25	24	24	23	23	22
69°35'	71°21'	28	27	27	26	26	25	25	24	24	23	23
71°21'	73°16'	28	28	27	27	26	26	25	25	24	24	23
73°16'	75°24'	29	28	28	27	27	26	26	25	25	24	24
75°24'	77°52'	29	29	28	28	27	27	26	26	25	25	24
77°52'	80°56'	30	29	29	28	28	27	27	26	26	25	25
80°56'	85°45'	30	30	29	29	28	28	27	27	26	26	25
85°45'	90°00'	31	30	30	29	29	28	28	27	27	26	26

3.4 Setup Menu

When the Indicator is used for the first time, enter this menu to set the Capacity and Graduation.

SETUP

Reset	No, Yes
Legal for Trade	Off, On
Calibration Unit	kg, lb
Capacity	5...20000
Graduation	0.0005...20
Power On Unit	Auto, kg, lb, g, oz
Zero Range	2%, 100%
Retain Zero Data	Off, On
End Setup	Exit SETUP menu

3.4.1 Reset

Reset the Setup menu to the factory defaults.

- No = not reset.
- Yes = reset.

RESET

NO

YES

3.4.2 Legal for Trade

Set the legal for trade status.

- OFF = off
- ON = on

LFT

OFF

ON

Turning on the "LFT" menu setting has the following effects:

- Zero-range is set and locked on "2".
- Auto Zero Tracking is set and locked on 0.5d
- The lb:oz unit is not available as a power-on setting.

3.4.3 Calibration Unit

Set the unit during calibration.

- CAL UN kg = Calibrate using kg weights
- CAL UN lb = Calibrate using pound weights

CALUN

3.4.4 Capacity

Set the scale capacity from 5 to 20000. Refer to the Setup Table 3.3 for available settings.

CAP

TABLE 3-3. SETUP AND CALIBRATION VALUES

Capacity	Graduation size with LFT OFF	Graduation size with LFT ON	Span calibration points	Linearity calibration points
5	0.0005, 0.001, 0.002, 0.005	0.001, 0.002, 0.005	5	2, 5
10	0.0005, 0.001, 0.002, 0.005, 0.01	0.002, 0.005, 0.01	5, 10	5, 10
15	0.001, 0.002, 0.005, 0.01	0.005, 0.01	5, 10, 15	5, 15
20	0.001, 0.002, 0.005, 0.01, 0.02	0.005, 0.01, 0.02	5, 10, 15, 20	10, 20
25	0.002, 0.005, 0.01, 0.02	0.005, 0.01, 0.02	5, 10, 15, 20, 25	10, 25
30	0.002, 0.005, 0.01, 0.02	0.005, 0.01, 0.02	5, 10, 15, 20, 25, 30	15, 30
40	0.002, 0.005, 0.01, 0.02	0.01, 0.02	5, 10, 15, 20, 25, 30, 40	20, 40
50	0.005, 0.01, 0.02, 0.05	0.01, 0.02, 0.05	5, 10, 15, 20, 25, 30, 40, 50	25, 50
60	0.005, 0.01, 0.02, 0.05	0.01, 0.02, 0.05	5, 10, 15, 20, 25, 30, 40, 50, 60	30, 60
75	0.005, 0.01, 0.02, 0.05	0.02, 0.05	5, 10, 15, 20, 25, 30, 40, 50, 60, 75	30, 75
100	0.005, 0.01, 0.02, 0.05, 0.1	0.02, 0.05, 0.1	5, 10, 15, 20, 25, 30, 40, 50, 60, 75, 100	50, 100
120	0.01, 0.02, 0.05, 0.1	0.02, 0.05, 0.1	5, 10, 15, 20, 25, 30, 40, 50, 60, 75, 100, 120	60, 120
150	0.01, 0.02, 0.05, 0.1	0.05, 0.1	5, 10, 15, 20, 25, 30, 40, 50, 60, 75, 100, 120, 150	75, 150
200	0.02, 0.01, 0.02, 0.05, 0.1, 0.2	0.05, 0.1, 0.2	5, 10, 15, 20, 25, 30, 40, 50, 60, 75, 100, 120, 150, 200	100, 200
250	0.05, 0.1, 0.2	0.05, 0.1, 0.2	5, 10, 15, 20, 25, 30, 40, 50, 60, 75, 100, 120, 150, 200, 250	120, 250
300	0.02, 0.05, 0.1, 0.2	0.05, 0.1, 0.2	5, 10, 15, 20, 25, 30, 40, 50, 60, 75, 100, 120, 150, 200, 250, 300	150, 300
400	0.02, 0.05, 0.1, 0.2	0.1, 0.2	5, 10, 15, 20, 25, 30, 40, 50, 60, 75, 100, 120, 150, 200, 250, 300, 400	200, 400
500	0.05, 0.1, 0.2, 0.5	0.1, 0.2, 0.5	5, 10, 15, 20, 25, 30, 40, 50, 60, 75, 100, 120, 150, 200, 250, 300, 400, 500	250, 500
600	0.05, 0.1, 0.2, 0.5	0.1, 0.2, 0.5	5, 10, 15, 20, 25, 30, 40, 50, 60, 75, 100, 120, 150, 200, 250, 300, 400, 500, 600	300, 600
750	0.05, 0.1, 0.2, 0.5	0.2, 0.5	5, 10, 15, 20, 25, 30, 40, 50, 60, 75, 100, 120, 150, 200, 250, 300, 400, 500, 600, 750	300, 750
1000	0.05, 0.1, 0.2, 0.5, 1	0.2, 0.5, 1	5, 10, 15, 20, 25, 30, 40, 50, 60, 75, 100, 120, 150, 200, 250, 300, 400, 500, 600, 750, 1000	500, 1000
1200	0.1, 0.2, 0.5, 1	0.2, 0.5, 1	5, 10, 15, 20, 25, 30, 40, 50, 60, 75, 100, 120, 150, 200, 250, 300, 400, 500, 600, 750, 1000, 1200	600, 1200
1500	0.1, 0.2, 0.5, 1	0.5, 1	5, 10, 15, 20, 25, 30, 40, 50, 60, 75, 100, 120, 150, 200, 250, 300, 400, 500, 600, 750, 1000, 1200, 1500	750, 1500
2000	0.1, 0.2, 0.5, 1, 2	0.5, 1, 2	5, 10, 15, 20, 25, 30, 40, 50, 60, 75, 100, 120, 150, 200, 250, 300, 400, 500, 600, 750, 1000, 1200, 1500, 2000	1000, 2000
2500	0.2, 0.5, 1, 2	0.5, 1, 2	5, 10, 15, 20, 25, 30, 40, 50, 60, 75, 100, 120, 150, 200, 250, 300, 400, 500, 600, 750, 1000, 1200, 1500, 2000, 2500	1200, 2500
3000	0.2, 0.5, 1, 2	0.5, 1, 2	5, 10, 15, 20, 25, 30, 40, 50, 60, 75, 100, 120, 150, 200, 250, 300, 400, 500, 600, 750, 1000, 1200, 1500, 2000, 2500, 3000	1500, 3000
5000	0.5, 1, 2, 5	1, 2, 5	5, 10, 15, 20, 25, 30, 40, 50, 60, 75, 100, 120, 150, 200, 250, 300, 400, 500, 600, 750, 1000, 1200, 1500, 2000, 2500, 3000, 5000	2500, 5000
6000	0.5, 1, 2, 5	1, 2, 5	5, 10, 15, 20, 25, 30, 40, 50, 60, 75, 100, 120, 150, 200, 250, 300, 400, 500, 600, 750, 1000, 1200, 1500, 2000, 2500, 3000, 5000, 6000	2500, 5000
7500	0.5, 1, 2, 5	2, 5	5, 10, 15, 20, 25, 30, 40, 50, 60, 75, 100, 120, 150, 200, 250, 300, 400, 500, 600, 750, 1000, 1200, 1500, 2000, 2500, 3000, 5000, 6000, 7500	3000, 7500
10000	0.5, 1, 2, 5, 10	2, 5, 10	5, 10, 15, 20, 25, 30, 40, 50, 60, 75, 100, 120, 150, 200, 250, 300, 400, 500, 600, 750, 1000, 1200, 1500, 2000, 2500, 3000, 5000, 6000, 7500, 10000	5000, 10000
12000	1, 2, 5, 10, 20	2, 5, 10	5, 10, 15, 20, 25, 30, 40, 50, 60, 75, 100, 120, 150, 200, 250, 300, 400, 500, 600, 750, 1000, 1200, 1500, 2000, 2500, 3000, 5000, 6000, 7500, 10000, 12000	6000, 12000
15000	1, 2, 5, 10, 20	5, 10	5, 10, 15, 20, 25, 30, 40, 50, 60, 75, 100, 120, 150, 200, 250, 300, 400, 500, 600, 750, 1000, 1200, 1500, 2000, 2500, 3000, 5000, 6000, 7500, 10000, 12000, 15000	7500, 15000
20000	1, 2, 5, 10, 20	5, 10, 20	5, 10, 15, 20, 25, 30, 40, 50, 60, 75, 100, 120, 150, 200, 250, 300, 400, 500, 600, 750, 1000, 1200, 1500, 2000, 2500, 3000, 5000, 6000, 7500, 10000, 20000	10000, 20000

3.4.5 Graduation

Set the scale readability.

0.0005, 0.001, 0.002, 0.005, 0.01, 0.02, 0.05, 0.1, 0.2, 0.5, 1, 2, 5, 10, 20.

NOTE: Not all settings are available for each capacity. Refer to the Setup Table 3.3 for available settings.

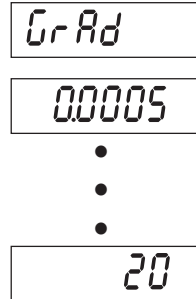

3.4.6 Power On Unit

Set the unit of measure displayed at startup.

- Auto = last unit in use when the indicator was turned off.
- Unit kg = kilograms
- Unit lb = pounds
- Unit g = grams
- Unit oz = ounces

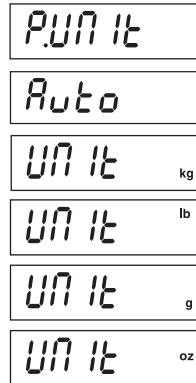

3.4.7 Zero Range

Set the percentage of scale capacity that may be zeroed.

- 0-2 = zero up to 2 percent of capacity
- 0-100 = zero up to full capacity



3.4.8 Retain Zero Data

Set the retain zero data status.

- OFF = disabled
- ON = when power is turned on, the displayed weight is based on the last stored zero.

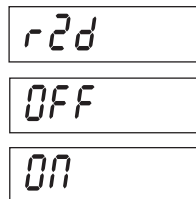

3.4.9 End Setup

Advance to the next menu.

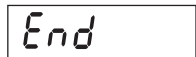

3.5 Readout Menu

Enter this menu to customize display functionality.



Reset	No , Yes
Stable	0.5d, 1d , 2d, 3d
Filter Level	Lo, Med , Hi
Auto-Zero Tracking	Off, 0.5d , 1d, 3d
Sleep (T32ME)	Off, On
Light (T32ME)	Lo, Med , Hi
Backlight (T32MC)	Off, On, Auto
Auto Off Timer	Off , Set 1, Set 2, Set 5
Expand	Off , On
End Readout	Exit READOUT menu

3.5.1 Reset

Set the Readout menu to factory default settings.

- No = not reset
- Yes = reset

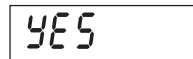
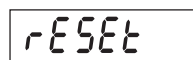

3.5.2 Stable

Set the amount the reading can vary while the stability symbol remains on.

- 0.5 d = 0.5 divisions
- 1 d = 1 division
- 2 d = 2 divisions
- 3 d = 3 divisions



3.5.3 Filter

Set the amount of signal filtering.

- LO = less stability, faster stabilization time
- MEd = normal stability, stabilization time
- HI = greater stability, slower stabilization time

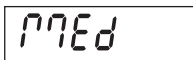
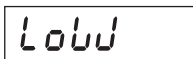
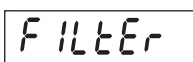

3.5.4 Auto-Zero Tracking

Set the automatic zero tracking functionality.

- OFF = disabled.
- 0.5 d = the display will maintain zero until a drift of 0.5 divisions per second has been exceeded.
- 1 d = the display will maintain zero until a drift of 1 division per second has been exceeded.
- 3 d = the display will maintain zero until a drift of 3 divisions per second has been exceeded.

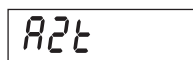

NOTE: When the LFT menu item is set to ON, the selections are limited to 0.5d. The setting is locked when the hardware lock switch is set to the ON position.

3.5.5 Sleep (T32ME)

Set the Sleep functionality.(display powers off after 60 seconds of inactivity)

- OFF = Disabled.
- ON = Enabled.

SLEEP

OFF

ON

3.5.6 Light (T32ME)

Set the brightness of LED display.

- LO = Low Intensity
- MEd = Medium Intensity
- HI = High Intensity

LIGHt

Low

MEd

HI

3.5.7 Backlight (T32MC)

Set the display backlight functionality.

- OFF = always off.
- ON = always on.
- AUTO = turns on when a button is pressed or the displayed weight changes.
turns off after 20 seconds of no activity.

LIGHt

OFF

ON

Auto

3.5.8 Auto Off Timer

Set the automatic shut off functionality.

- OFF = disabled
- SEt 1 = powers off after 1 minute of no activity.
- SEt 2 = powers off after 2 minutes of no activity.
- SEt 5 = powers off after 5 minutes of no activity.

AOFF

OFF

SEt 1

SEt 2

SEt 5

3.5.9 Expand Mode (For testing purposes only)

Set the expand mode to display raw counts.

- OFF = Disabled.
- ON = Enabled.

EPANd

OFF

ON

3.5.10 End Readout

Advance to the next menu.

End

3.6 Mode Menu

Enter this menu to activate the desired application modes.

MODE

Reset	No , Yes
Count	Off , On
Hold	Off , On
Check	Off , On
Totalize	Off , On
End Mode	Exit MODE menu

3.6.1 Reset

Set the Mode menu to the factory defaults.

- No = not reset.
- Yes = reset.

RESET

NO

YES

3.6.2 Parts Counting Mode

Set the status.

- OFF = Disabled
- ON = Enabled

COUNT

OFF

ON

3.6.3 Display-Hold Mode

Set the status.

- OFF = Disabled
- ON = Enabled

HOLD

OFF

ON

3.6.4 Checkweigh Mode

Set the status.

- OFF = Disabled
- ON = Enabled

CHECK

OFF

ON

3.6.5 Totalize Mode

Set the status.

- OFF = Disabled
- ON = Enabled

TOTAL

OFF

ON

3.6.6 End Mode

Advance to the next menu.

End

3.7 Unit Menu

Enter this menu to activate the desired units. Default settings are bold.

UNIT

Reset	No , Yes
Kilogram	Off, On
Pound	Off , On
Gram	Off , On
Ounce	Off , On
Pound Ounce	Off , On
End Unit	Exit UNIT menu

3.7.1 Reset

Set the Unit menu to the factory defaults.

Settings:

- NO = not reset.
- YES = reset

RESET

NO

YES

3.7.2 Kilogram Unit

Set the status.

- OFF = Disabled
- ON = Enabled

UNIT kg

OFF

ON

3.7.3 Pound Unit

Set the status.

- OFF = Disabled
- ON = Enabled

UNIT lb

OFF

ON

3.7.4 Gram Unit

Set the status.

- OFF = Disabled
- ON = Enabled

UNIT g

OFF

ON

3.7.5 Ounce Unit

Set the status.

- OFF = Disabled
- ON = Enabled

UNIT oz

OFF

ON

3.7.6 Pound Ounce Unit

Set the status.

- OFF = Disabled
- ON = Enabled

UNIT lb oz

OFF

ON

3.7.7 End Unit

Advance to the next menu.

End

3.8 Print Menu

Enter this menu to define printing parameters.

Default settings are bold.

Pr. int

Reset	No , Yes
Baud Rate	300, 600, 1200, 2400, 4800, 9600 , 19200
Parity	7 Even, 7 Odd, 7 None, 8 None
Stop Bit	1 , 2
Handshake	Off, XON/XOFF
Stable Only	Off , On
Auto Print	Off , On Stable (-> Load, Load and Zero), Interval (-> 1...3600), Continuous
Content	Gross (-> Off , On) Net (-> Off , On) Tare (-> Off , On) Unit (-> Off , On)
End Print	Exit PRINT menu

3.8.1 Reset

Set the Print menu to factory defaults.

- NO = not reset.
- YES = reset.

rESEt

no

YES

3.8.2 Baud

Set the Baud rate.

- 300 = 300 bps
- 600 = 600 bps
- 1200 = 1200 bps
- 2400 = 2400 bps
- 4800 = 4800 bps
- 9600 = 9600 bps
- 19200 = 19200 bps

bAUD

300

600

1200

2400

4800

9600

19200

3.8.3 Parity

Set the data bits and parity.

- 7 EVEN = 7 data bits, even parity.
- 7 Odd = 7 data bits, odd parity.
- 7 NONE = 7 data bits, no parity.
- 8 NONE = 8 data bits, no parity.

PAR ity

7 EVEN

7 Odd

7 NONE

8 NONE

3.8.4 Stop Bit

Set the number of stop bits.

- 1 = 1 stop bit.
- 2 = 2 stop bits.

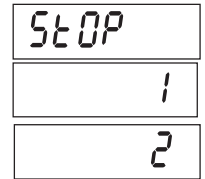

3.8.5 Handshake

Set the flow control method.

- OFF = no handshaking.
- ON-OFF = XON/XOFF software handshaking.



3.8.6 Print Stable Data Only

Set the print criteria.

- OFF = values are printed immediately.
- ON = values are only printed when the stability criteria are met.

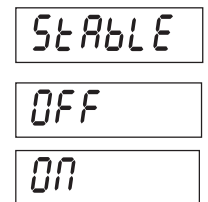

3.8.7 Auto Print

Set the automatic printing functionality.

- OFF = disabled.
- ON.StAb = printing occurs each time the stability criteria are met.
- INtEr = printing occurs at the defined interval.
- CONt = printing occurs continuously.



When INtEr is selected, set the Print Interval.

1 to 3600 (seconds)

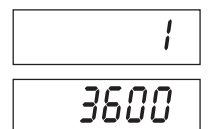

3.8.8 Content

Select the additional content of the printout.

- GROSS OFF = Gross weight is not printed.
- ON = Gross weight is printed.
- NET OFF = Net weight is not printed.
- ON = Net weight is printed.
- TARE OFF = Tare weight is not printed.
- ON = Tare weight is printed.
- UNIT OFF = Weighing Unit is not printed.
- ON = Weighing Unit is printed.



3.8.9 End Print

Advance to the next menu.



3.9 Lock Menu

Use this menu to prevent unauthorized changes to menu settings. Default settings are bold.

LOCK

Reset	No , Yes
Lock Calibration Menu	Off , On
Lock Setup Menu	Off , On
Lock Readout Menu	Off , On
Lock Mode Menu	Off , On
Lock Unit Menu	Off , On
Lock Print Menu	Off , On
End Lock Menu	Exit LOCK Menu

3.9.1 Reset

Set the menu Lock menu to factory defaults.

- NO = not reset.
- YES = reset.

RESET

NO

YES

3.9.2 Lock Calibration

Set the status.

- OFF = Calibration menu is not locked.
- ON = Calibration menu is locked and hidden.

LCAL

OFF

ON

3.9.3 Lock Setup

Set the status.

- OFF = Setup menu is not locked.
- ON = Setup menu is locked and hidden.

LSETUP

OFF

ON

3.9.4 Lock Readout

Set the status.

- OFF = Readout menu is not locked.
- ON = Readout menu is locked and hidden.

LREAD

OFF

ON

3.9.5 Lock Mode

Set the status.

- OFF = Mode menu is not locked.
- ON = Mode menu is locked and hidden.

LMODE

OFF

ON

3.9.6 Lock Unit

Set the status.

- OFF = Unit menu is not locked.
- ON = Unit menu is locked and hidden.

LUNIT

OFF

ON

3.9.7 Lock Print

Set the status.

- OFF = Print menu is not locked.
- ON = Print menu is locked and hidden

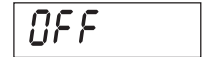
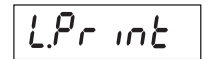

3.9.8 End Lock

Advance to the next menu.



3.10 End Menu

Exit to weighing.



3.11 Security Switch

A security switch is located on the Main PCB board. When the switch is set to the on position, user menu settings that were locked in the Menu Lock can not be changed. Open the housing as explained in Section 2.3.1. Set the position of security switch to ON as shown in Figure 1-2.

4 OPERATION

4.1 Turning Indicator On/Off

To turn the Indicator on, press and hold the **ON/ZERO Off** button for 2 seconds. The Indicator performs a display test, momentarily displays the software version, and then enters the active weighing mode.

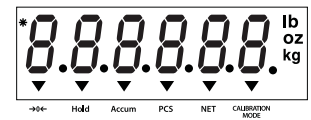

To turn the Indicator off, press and hold the **ON/ZERO Off** button until OFF is displayed.

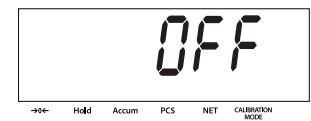

4.2 Zero Operation

Zero can be set under the following conditions:

- Automatically at Power On (initial zero).
- Semi-automatically (manually) by pressing the **ON/ZERO Off** button.
- Semi-automatically by sending the Zero command (Z or alternate zero command).

Press the **ON/ZERO Off** button to zero the weight display. The scale must be stable to accept zero operation.

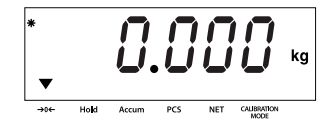

4.3 Manual Tare

When weighing an item that must be held in a container, taring stores the container weight in memory. Place the empty container on the scale (example 0.5 kg) and press the **TARE** button. The display will show the net weight.

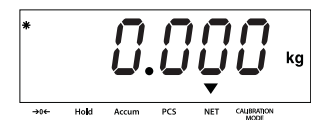
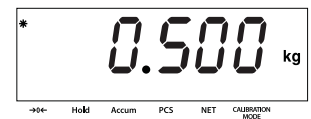

To clear the Tare value, empty the scale and press the **TARE** button. The display will show the gross weight.



4.4 Changing Units of Measure

Press and hold the **PRINT Units** button until the desired measuring unit appears. Only measuring units enabled in the Unit Menu will be displayed (refer to Section 3.7).

4.5 Printing Data

Printing the displayed data to a printer or sending the data to a computer requires that the communication parameters in the Print Menu are set (refer to Section 3.8).

Press the **PRINT Units** button to send the displayed data to the communication port (the Auto-Print Mode in Section 3.8 function must be Off).

4.6 Application Modes

Only modes enabled in the mode menu will be displayed (refer to Section 3.6).

4.6.1 Weighing

Place the item to be weighed on the scale. The illustration indicates a sample of 1.5 kg, Gross weight.

Note: To return to the Weighing mode from the other modes, press and hold the **Mode** button until WEIGH is displayed.

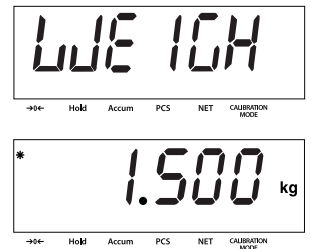

4.6.2 Parts Counting

Use this mode to count parts of uniform weight. The Indicator determines the quantity based on the average weight of a single part. All parts must be uniform in weight for accurate measurements.

To enter the Parts Counting mode, press and hold the **Mode** button until Count is displayed.

Average Piece Weight (APW)

When the **Mode** button is released, Clr.PW Pcs is displayed.

NOTE: If no APW has been previously stored, the Clr.PW display is skipped and the display shows PU10Pcs.

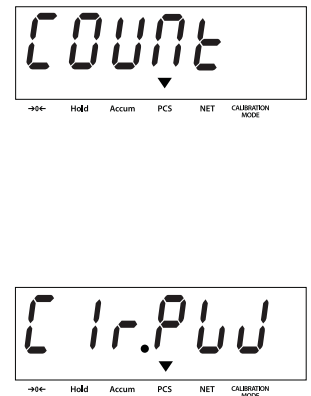

Clearing a Stored APW

Press the **Yes** button to clear the stored APW.

Recalling a Stored APW

Press the **No** button to recall the existing APW, then proceed to counting operation.

Establishing the Average Piece Weight (APW)

The display shows Put 5 Pcs.

Establishing a New APW

Press the **No** button to increment the sample size. Choices are 5, 10, 20, 50, 100 and 200.

To establish the APW, place the specified quantity of samples on the scale and press the **Yes** button to capture the weight.

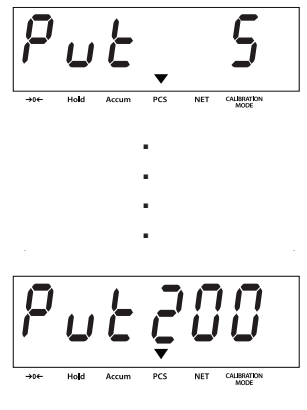

Begin Counting

Place the parts on the scale and read the count. If a container is used, be sure to tare the empty container first.

Viewing the Average Piece Weight (APW)

Press the **FUNCTION Mode** button to temporarily display the APW value.

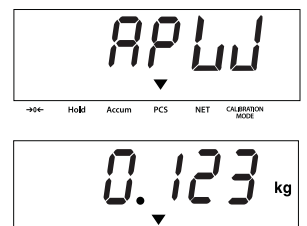

4.6.3 Display-Hold

Use this mode to capture and store the first stable display value.

To enter the Display hold mode, press and hold the **Mode** button until HOLD is displayed.

When the **Mode** button is released, the Hold indicator will be turned on.

Place the item on the scale, The first stable value will be held on the display and the Hold icon will blink. When a successive weight is added to the scale the display will show the new value. Even after removing the items, the weight will be held on the display.

To clear the held value, press **Mode** button.

NOTE: Press and hold the **Mode** button to enter other modes.

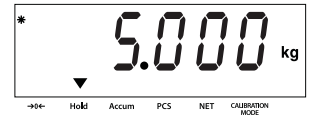
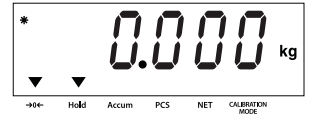
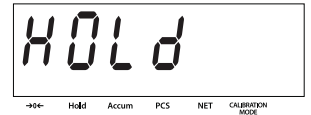

4.6.4 Check Weighing

Use this mode to determine if the weight of a sample is within Pre-set limits.

Checkweighing Limits

When the **FUNCTION Mode** button is released, Clr.rEF is displayed.

Using or Recalling Stored Check Weighing Limits

Press the **No** button to recall the stored limits and proceed to checkweigh operation

Clearing Stored Check Weighing Limits

Press the **Yes** button to clear the stored limits.

NOTE: Press the **FUNCTION Mode** button successively to temporarily display the Under and Over Limit values.

Editing the Under Setting

The display shows SET.LO. Press the **Yes** button to edit setting..

Settings:

-99999 to 999999

Refer to Menu Navigation Section 3.2 to enter settings.

NOTE: The first digit will be used to show a negative value. Adjust the readability setting as needed to allow an extra digit taken up by the negative sign

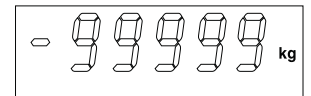
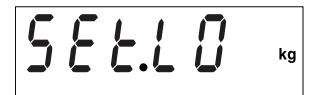
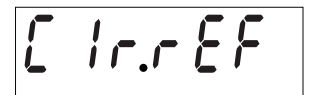
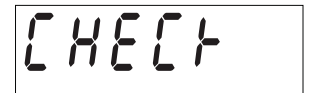

to

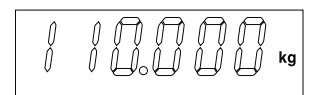
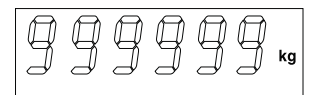

Editing the Over Setting

The display shows SEt.HI.

Press the **Yes** button to edit the Over setting.



Settings:

-99999 to 999999

Refer to Menu Navigation Section 3.2 to enter settings.

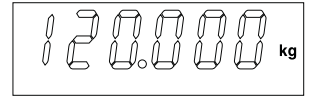

Begin Check Weighing

The appropriate Under, Accept or Over LED lights to indicate Check Weigh status.

Place a sample on the scale and read the weight.



For loads less than the Under Limit, the yellow Under LED is lit.



For loads greater than the Under Limit and less than the Over limit, the green Accept LED is lit.

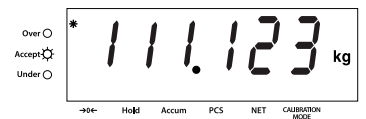

For loads greater than the Over Limit, the red Over LED is lit.

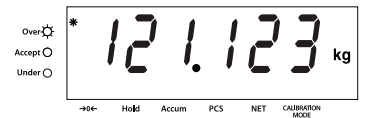

4.6.5 Totalize Weighing

Use this mode to store the total of a series of weight measurements.

NOTE: Only positive numbers will be totaled.



Accumulation (ACC)

When the **Mode** button is released, CLr.Acc Accum is displayed.

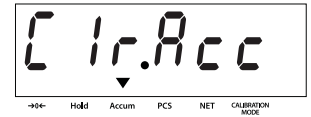

Start Totalize

Press the **Yes** button to clear the stored data and start new totalize.

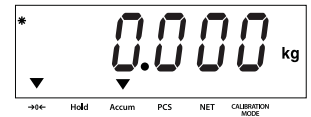

Continue Totalize

Press the **No** button to recall the existing data and continue totalize.

Begin Totalize

Place the items on the scale and press **Mode** button. The Accum indicator will blink to show the value is added to the memory. Remove the item (scale must return to zero) before the next item placed on the scale can be accumulated.



To display totalize data, with no weight on pan:

Press the **Mode** button to display "n x"

(n = total no. of samples, max ~999).

Press **Mode** button again to display "xxx.xx kg"

(total sum of weights to ~999,999 before display shows "Err 5.0").

Press **Mode** button again to return back to original display.

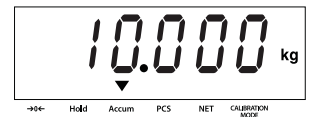
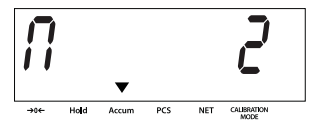

NOTE: Changing the units will clear the accumulated data.

If the total value exceeds the display capability, the scale will truncate the last decimal digit.

Error 5 is displayed when 999999 is exceeded.

5 SERIAL COMMUNICATION

The setup of RS232 operating parameters are fully explained in Section 3.8. The physical hardware connection is explained in in Section 2.2.

The interface enables display data to be sent to a computer or printer. A computer can be used to control some functions of the indicator using the commands listed in Table 5-1.

5.1 Interface Commands

Communicate to the indicator using the command characters listed in Table 5-1.

TABLE 5-1. SERIAL INTERFACE COMMAND TABLE.

Command Character	Function
IP	Immediate Print of displayed weight (stable or unstable).
P	Print stable displayed weight (according to stability setting).
CP	Continuous Print.
SP	Print when stable.
xP	Interval Print x = Print Interval (1-3600 sec)
Z	Same as pressing Zero button
T	Same as pressing Tare button
xT	Download Tare value in grams (positive values only). Sending 0T clears tare (if allowed)
PU	Print current unit: g, kg, lb, oz, lb:oz
xU	Set scale to unit x: 1=g, 2=kg, 3=lb, 4=oz, 5=lb:oz
PV	Version: print name, software revision and LFT ON (if LFT is set ON).
Esc R	Global reset to reset all menu settings to the original factory defaults

NOTES:

- Commands sent to the Indicator must be terminated with a carriage return (CR) or carriage return-line feed (CRLF).
- Data output by the Indicator is always terminated with a carriage return-line feed (CRLF).
- The xT (preset tare) command is not available when LFT is set to ON.

5.2 Output Format

The default serial output format is shown below.

Field:	Polarity	Space	Weight	Space	Unit	Stability	Legend	CR	LF
Length:	1	1	7	1	5	1	3	1	1

Definitions: Polarity, "-" sign if negative, blank if positive.

Weight, up to 6 numbers and 1 decimal, right justified, leading zero blanking.

Units, up to 5 characters.

Stability, "?" character is printed if not stable, blank if stable.

Legend, up to 3 characters: G = gross weight, NET = net weight, T = tare

6. LEGAL FOR TRADE

When the indicator is used in trade or a legally controlled application it must be set up, verified and sealed in accordance with local weights and measures regulations. It is the responsibility of the purchaser to ensure that all pertinent legal requirements are met.

6.1 Settings

Before verification and sealing, perform the following steps:

1. Verify that the menu settings meet the local weights and measures regulations.
2. Perform a calibration.
3. Set Legal for Trade to ON in the Setup menu.
4. Exit the menu.
5. Disconnect power from the indicator and open the housing as explained in Section 2.3.1.
6. Set the position of the security switch to ON as shown in Section 1.2, Item 2.
7. Close the housing.
8. Reconnect power and turn the indicator on.

NOTE: For installations that employ the audit trail sealing method, steps 5 to 8 are not required. However, the security switch may be set to ON to safeguard against unintentional changes to configuration and calibration settings.

NOTE: When Legal for Trade is set to ON and the security switch is set to ON, the following menu settings cannot be changed: Span Calibration, Linearity Calibration, GEO, LFT, Calibration Unit, Capacity, Graduation, Power On Unit, Zero Range, Auto Zero Tracking, Expanded Mode, Count Mode, Kilogram Unit, Pound Unit, Gram Unit, Ounce Unit, Pound Ounce Unit, Stable Only. To enable editing of these menu settings, return the security switch to the off position and set LFT menu item to off.

6.2 Verification

The local weights and measures official or authorized service agent must perform the verification procedure. Please contact your local weights and measures office for further details.

6.3 Sealing

6.3.1 Physical Seals

For jurisdictions that use the physical sealing method, the local weights and measures official or authorized service agent must apply a security seal to prevent tampering with the settings. Refer to the illustrations below for sealing methods.

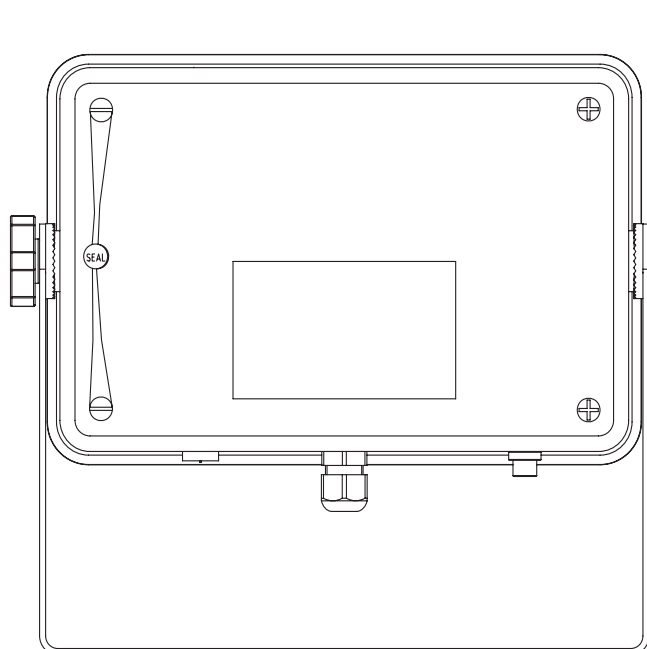

Figure 6-1. Wire Seal

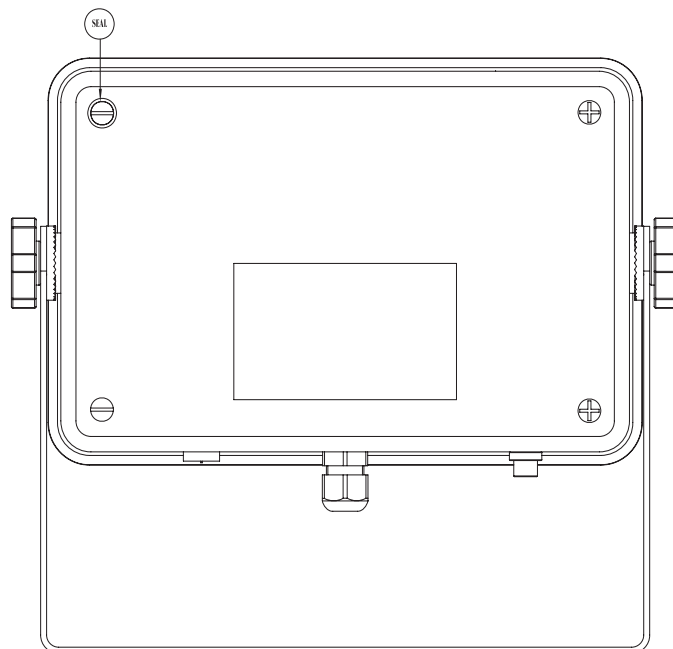

Figure 6-2. Paper Seal

6.3.2 Audit Trail Seal

For jurisdictions that use the audit trail sealing method, the local weights and measures official or authorized service agent must record the current configuration and calibration event counter values at the time of sealing. These values will be compared to values found during a future inspection.

NOTE: A change to an event counter value is equivalent to breaking a physical seal.

The audit trail uses two event counters to record changes to configuration and calibration settings.

- The configuration event counter (CFG) will index by 1 when exiting the menu if one or more of the following settings are changed: Legal for Trade, Calibration Unit, Capacity, Graduation, Power On Unit, Zero Range, Auto Zero Tracking, Expanded Mode, Count Mode, Kilogram Unit, Pound Unit, Gram Unit, Ounce Unit, Pound Ounce Unit, Stable Only. Note that the counter only indexes once, even if several settings are changed. The configuration event counter values range from CFG000 to CFG999. When the value reaches CFG999, the count starts over at CFG000.
- The calibration event counter (CAL) will index by 1 when exiting the menu if a Span Calibration, Linearity Calibration or GEO setting change is made. Note that the counter only indexes once, even if several settings are changed. The calibration event counter values range from CAL000 to CAL999. When the value reaches CAL999, the count starts over at CAL000.

The event counters can be viewed by pressing and holding the MENU button. While the button is held, the display will show MENU followed by Audit.



Release the button when Audit is displayed to view the audit trail information.



The audit trail information is displayed in the format CFGxxx and CALxxx.

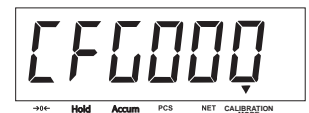

Then the indicator returns to normal operation.

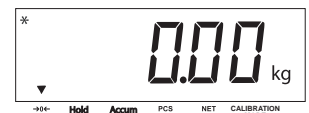

7 MAINTENANCE



CAUTION: DISCONNECT THE UNIT FROM THE POWER SUPPLY BEFORE CLEANING.

7.1 Indicator Cleaning

- The housing may be cleaned with a cloth dampened with a mild detergent if necessary.
- Do not use solvents, chemicals, alcohol, ammonia or abrasives to clean the housing or control panel.

7.2 Troubleshooting

TABLE 7-1. TROUBLESHOOTING.

SYMPTOM	PROBABLE CAUSE(S)	REMEDY
Unit will not turn on.	Power cord not plugged in or properly connected. Power outlet not supplying electricity. Other failure.	Check power cord connections. Make sure power cord is plugged in properly into the power outlet. Check power source. Service required.
Cannot zero the Scale, or will not zero when turned on.	Load on Scale exceeds allowable limits. Load on Scale is not stable. Load Cell damage.	Remove load on Scale. Wait for load to become stable. Service required.
Unable to calibrate.	Lock Calibration Menu set to On. Lock switch is "on". LFT menu set to On. Incorrect value for calibration mass.	Set Lock Calibration Menu to Off. Refer to Section 3.9 Menu Lock. Set the Lock switch to Off. Set LFT menu to Off. Use correct calibration mass.
Cannot display weight in desired weighing unit.	Unit not set to On.	Enable unit in the Units Menu. Refer to Section 3.7 in the Unit Menu.
Cannot change menu settings.	Menu has been locked. Lock switch set on.	Set selected menu to Off in the Lock Menu. Lock Switch on the circuit board may need to be set to the Off position. Set the Lock switch to off.
Err 5.0	Display value > 999999 (parts counting mode)	Reduce number of parts
Err 7.0	Unstable weight reading when defining reference weight.	Unstable Error, check platform location.

TABLE 7-1. TROUBLESHOOTING (Cont.).

SYMPTOM	PROBABLE CAUSE(s)	REMEDY
Err 8.1	Weight reading exceeds Power On Zero limit.	Remove load from scale. Recalibrate scale.
Err 8.2	Weight reading below Power On Zero limit.	Add load to scale. Recalibrate scale.
Err 8.3	Weight reading exceeds Overload limit.	Reduce load on scale.
Err 8.4	Weight reading below Underload limit.	Add load to scale. Recalibrate scale.
Err 9.0	Internal fault	Service required.
Err 9.5	Calibration data not present.	Calibrate scale.
Err 53	EEPROM data incorrect.	Service required.
CAL E	Calibration Error. Calibration value outside allowable limits.	Repeat calibration using correct calibration weights.
LOW.rEF	The average piece weight of the parts is small (warning).	Use parts with average piece weight greater than or equal to 1 division.
REF.WT Err	The average piece weight of the parts is too small.	Use parts with a average piece weight greater than or equal to 0.1 division.

7.3 Service Information

If the troubleshooting section does not resolve your problem, contact an authorized Ohaus Service Agent. For Service assistance in the United States, call toll-free 1-800-526-0659 between 8:00 AM and 5:00 PM Eastern Standard Time. An Ohaus Product Service Specialist will be available to assist you. Outside the USA, please visit our website www.ohaus.com to locate the Ohaus office nearest you.

8. TECHNICAL DATA

8.1 Specifications

Materials

Housing Rear: Carbon-steel
 Housing Front: ABS plastic
 Keypad: Polyester
 Display Window: Polycarbonate

Ambient conditions

The technical data is valid under the following ambient conditions:

Ambient temperature: -10°C to 40°C / 14°F to 104°F

Relative humidity: Maximum relative humidity 80% for temperatures up to 31°C decreasing linearly to 50% relative humidity at 40°C.

Altitude: up to 2000m

Pollution degree: 2

Installation category: Class II.

TABLE 8-1. SPECIFICATIONS

Indicator	T32MC	T32ME
Capacity Range	5 to 20000 kg or lb	
Maximum Displayed Resolution	1:20,000	
Maximum Approved Resolution	1:6,000	
Minimum Average Piece wt. (APW)	1d	
Weighing Units	kg, lb, g, oz, lb-oz	
Functions	Weighing, Parts Counting, Display Hold, Checkweigh, Totalize	
Display	1 in./2.5 cm digit height, 6-digit, 7-segment; backlit LCD	0.8" / 20mm digit height, 6-digit, 7-segment Red LED
Backlight	White LED	---
Keypad	4-button mechanical switches	
Load Cell Excitation Voltage	5V DC	
Load Cell Drive	Up to 4 x 350 ohm Load Cells	
Load Cell Input Sensitivity	Up to 3 mV/V	
Stabilization Time	Within 2 Seconds	
Auto-zero Tracking	Off, 0.5, 1 or 3 Divisions	
Zeroing Range	2% or 100% of Capacity	
Span Calibration	5 kg or 5 lb to 100% Capacity	
Interface	RS232	
Overall Dimensions (W x D x H) (in/mm)	7.8 x 1.8 x 5.2 / 198 x 46 x 132	
Net Weight (lb/kg)	1.5 / 0.7	
Shipping Weight (lb/kg)	4.0 / 1.8	
Operating Temperature Range	-10°C to 40°C/14°F to 104°F	
Power	9 - 12 VDC, 0.5A, AC Adapter	

8.2 Accessories

TABLE 8-2. ACCESSORIES.

DESCRIPTION	PART NUMBER
Interface Cable/PC 25-pin, T32M	80500524
Interface Cable/PC 9-pin, T32M	80500525

8.3 Drawings and Dimensions

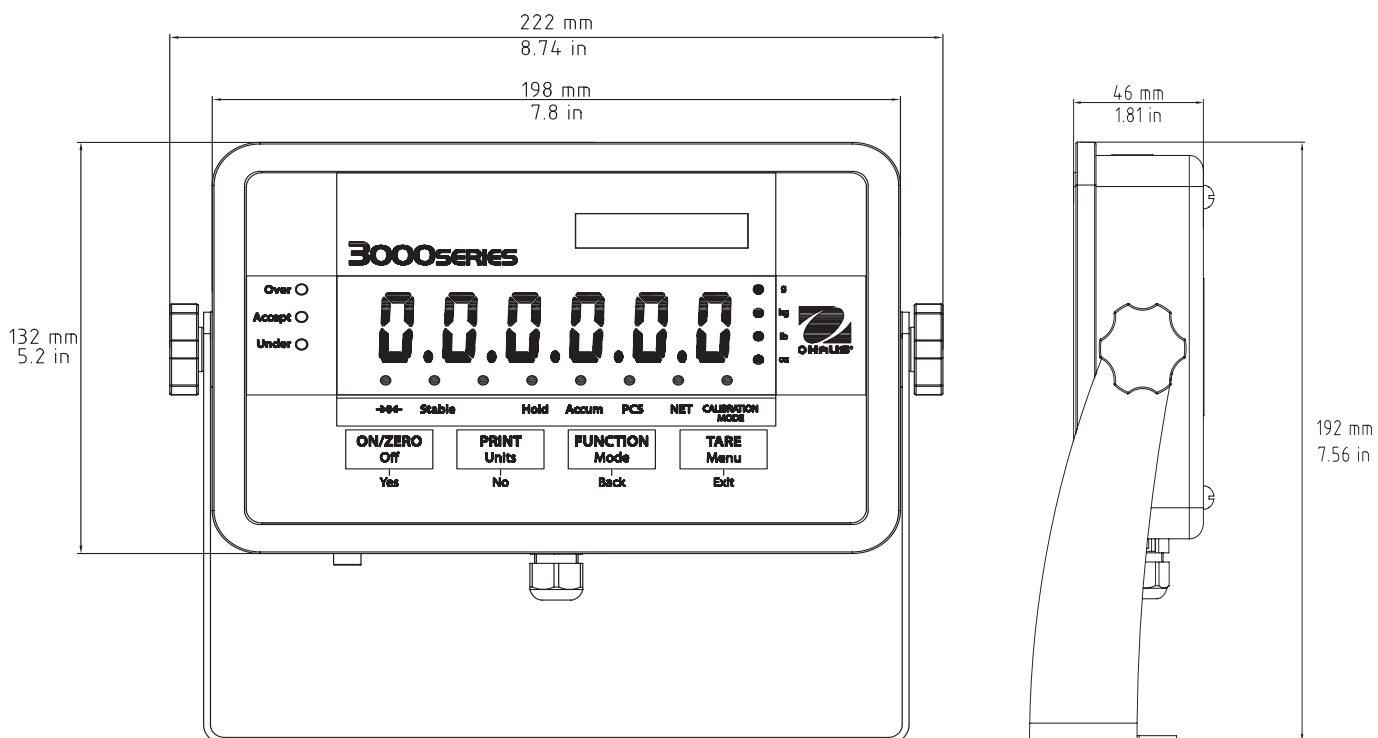





Figure 8-1. T32M Indicator Overall Dimensions.

8.4 Compliance

Compliance to the following standards is indicated by the corresponding mark on the product.

Marking	Standard
	This product conforms to the EMC directive 2004/108/EC, the Low Voltage Directive 2006/95/EC and the Non-automatic Weighing Instruments Directive 2009/23/EC. The complete Declaration of Conformity is available online at www.ohaus.com .
	AS/NZS4251.1 Emission, AS/NZS4252.1 Immunity
	CAN/CSA-C22.2 No. 61010-1-04, UL Std. No. 61010A-1

EC Emissions Note

This device complies with EN55011/CISPR 11 Class B Group 1.

Important notice for verified weighing instruments



Weighing Instruments verified at the place of manufacture bear one of the preceding mark on the packing label and the green 'M' (metrology) sticker on the descriptive plate. They may be put into service immediately.



Weighing Instruments to be verified in two stages have no green 'M' (metrology) on the descriptive plate and bear one of the preceding identification mark on the packing label. The second stage of the initial verification must be carried out by the approved service organization of the authorized representative within the EC or by the national weight & measures (W+M) authorities.

The first stage of the initial verification has been carried out at the manufacturers work. It comprises all tests according to the adopted European standard EN 45501:1992, paragraph 8.2.2.

If national regulations limit the validity period of the verification, the user of the weighing instrument must strictly observe the re-verification period and inform the respective W+M authorities.

**Disposal**

In conformance with the European Directive 2002/96/EC on Waste Electrical and Electronic Equipment (WEEE) this device may not be disposed of in domestic waste. This also applies to countries outside the EU, per their specific requirements.

Please dispose of this product in accordance with local regulations at the collecting point specified for electrical and electronic equipment.

If you have any questions, please contact the responsible authority or the distributor from which you purchased this device.

Should this device be passed on to other parties (for private or professional use), the content of this regulation must also be related.

For disposal instructions in Europe, refer to www.ohaus.com, choose your country then search for WEEE.

Thank you for your contribution to environmental protection.

FCC Note

This equipment has been tested and found to comply with the limits for a Class A digital device, pursuant to Part 15 of the FCC Rules. These limits are designed to provide reasonable protection against harmful interference when the equipment is operated in a commercial environment. This equipment generates, uses, and can radiate radio frequency energy and, if not installed and used in accordance with the instruction manual, may cause harmful interference to radio communications. Operation of this equipment in a residential area is likely to cause harmful interference in which case the user will be required to correct the interference at his own expense.

Industry Canada Note

This Class A digital apparatus complies with Canadian ICES-003.
Cet appareil numérique de la classe A est conforme à la norme NMB-003 du Canada.

ISO 9001 Registration

In 1994, Ohaus Corporation, USA, was awarded a certificate of registration to ISO 9001 by Bureau Veritas Quality International (BVQI), confirming that the Ohaus quality management system is compliant with the ISO 9001 standard's requirements. On May 21, 2009, Ohaus Corporation, USA, was re-registered to the ISO 9001:2008 standard.

LIMITED WARRANTY

Ohaus products are warranted against defects in materials and workmanship from the date of delivery through the duration of the warranty period. During the warranty period Ohaus will repair, or, at its option, replace any component(s) that proves to be defective at no charge, provided that the product is returned, freight prepaid, to Ohaus.

This warranty does not apply if the product has been damaged by accident or misuse, exposed to radioactive or corrosive materials, has foreign material penetrating to the inside of the product, or as a result of service or modification by other than Ohaus. In lieu of a properly returned warranty registration card, the warranty period shall begin on the date of shipment to the authorized dealer. No other express or implied warranty is given by Ohaus Corporation. Ohaus Corporation shall not be liable for any consequential damages.

As warranty legislation differs from state to state and country to country, please contact Ohaus or your local Ohaus dealer for further details.



Ohaus Corporation
7 Campus Drive
Suite 310
Parsippany, NJ 07054, USA
Tel: (973) 377-9000
Fax: (973) 944-7177
www.ohaus.com



P/N 80252856 A © 2011 Ohaus Corporation, all rights reserved.

Printed in China