

CCB SERIES

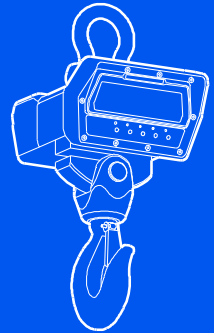

Crane Scale



CAS

NOTE

- (1) The unauthorized copying of some or all of this manual is prohibited.
- (2) The information contained herein is subject to change without notice.
- (3) If there are any questions such as wrong or missing parts of the contents listed in this manual, please contact us.
- (4) To improve the product performance, functions can be changed with no notice.
- (5) Please understand that CAS does not have responsibility for a demand related to loss, lost profit etc. caused by operating the product, regardless of the third clause.

WARNING DEFINITIONS	
	This is warning & caution mark
	This is hazard alert mark
	This is useful information mark

CONTENTS

1. Precautions	5
2. Main Features	5
3. Specifications.....	6
4. Description of Panels and Symbols	8
5. How to Use a Rechargeable Battery	9
6. General Functions.....	10
7. Setting Mode	11
8. Test Mode.....	16
9. IR Remote Controller	17
10. Wireless Specification (F model).....	17
11. Real Time Clock (F model).....	18
12. Wireless Pairing (F model).....	19
13. Check Message	20

1. Precautions

 Please be informed that we're not responsible for any incident or mishap caused by partial modification of this product. To avoid such situation, customers need to contact our customer service team or system installation staff in advance, and any modification should be conducted under our surveillance.

- Do not put too much pressure to keys. Light touching is enough to operate products.
- Do not use inflammable substances for cleaning.
- Do not use the product in the rain. Keep it dry.
- Avoid sudden changes of temperature if possible
- Do not use the product in a place with a high-voltage current or severe electronic noise.
- Keep the product in a dry place.
- Do not use the product in a place with strong direct sunlight and dust.
- Do not use the product in a place with severe vibration.
- Check the supply voltage.
- Please check if the safety hook is connected well before you install our CCB, so that the SHACKLE is not separated.

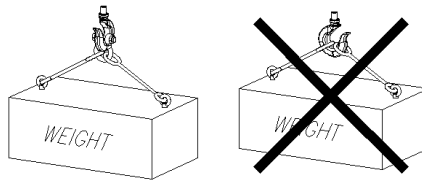

2. Main Features

- Swivel hook
- Big size display
- Easy to exchange battery pack (Li-Po battery)
- Standard IR remote controller
- LAN communication is possible using the ZigBee (F model)
- ZigBee wireless application and real time clock (F model)

3. Specifications

◆ Overall view

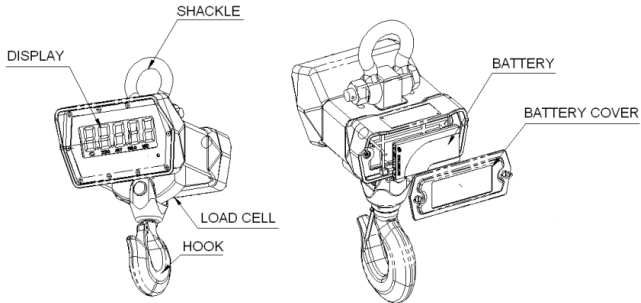

◆ Dimensions

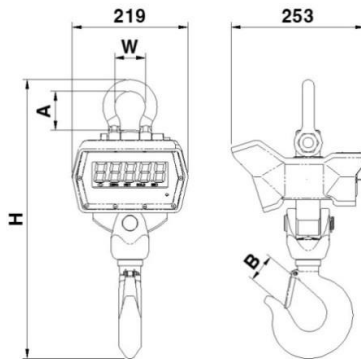

MODEL	Max (kg/lb)	e=d= (kg/lb)	Weight (kg)	DIMMENSION(mm)			
				H	A	W	B
CCB-1TL(F)	1,000/2,000	0.2/0.5	8.9	407	62	50	25
CCB-3TL(F)	2,500/5,000	0.5/1	15.2	525	73	57	34
CCB-5TL(F)	5,000/10,000	1/2	16.7	525	73	57	40
CCB-10TL(F)	10,000/20,000	2/5	26.9	697	101	83	55

(F) means that ZigBee wireless option is applied to product.

◆ Specifications

MODEL	CCB-L
Display	6 digit FSTN LCD 30mm & LED backlight
Operating time	Approx. 300hr
Battery	3.7V \times 3
Power adaptor	5V \times 1A
Display lamp	Low battery, Zero, Tare, Hold, Stable
Function	ON/OFF, Zero, Tare, HOLD, *
Temperature	- 20°C ~ +60°C
Max. tare weight	Full Tare
Safety overload	150% of capacity
Zero point	Within 2% of Maximum Weight
Initial zero band	Within 10% of Maximum Weight
Parts	Infrared controller, Power adaptor, Manual

◆ Parts

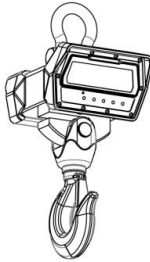

[Crane scale]

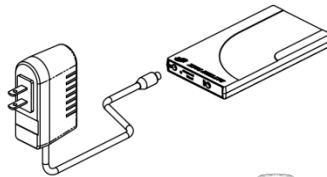

[Rechargeable adaptor]



[Infrared remote controller]

4. Description of Panels and Symbols

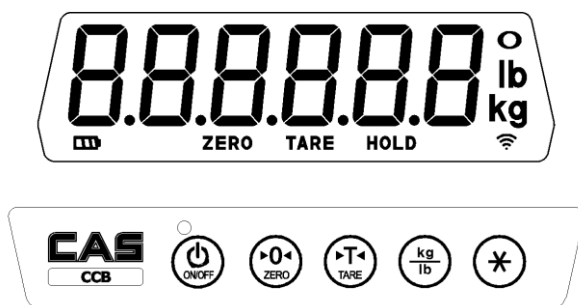

◆ Display

888888	Display the weight data & message
	Displayed when the weight is stable
kg lb	Indicates the weighing unit
	Indicates when the ZigBee communicates data
ZERO	Indicates when the weight is zero
TARE	Indicates when the tare is included
HOLD	Indicates when the hold function is set
	Indicates when a battery has to be recharged

◆ Keypad

	Power on and off the scale.
	Return the display to zero
	Used to weigh an item by using the container
	Used to change unit
	Use to turn on and off the backlight / hold function

5. How to Use a Rechargeable Battery

(1) Method of recharge battery

- Check the power supply voltage.
- If adaptor is still being charged, the RED lamp is on as below picture.
- If a charging is completed, the RED lamp is off.
The battery charging time takes about 6 hours.
(The battery charging time is subject to be changed according to battery condition.)

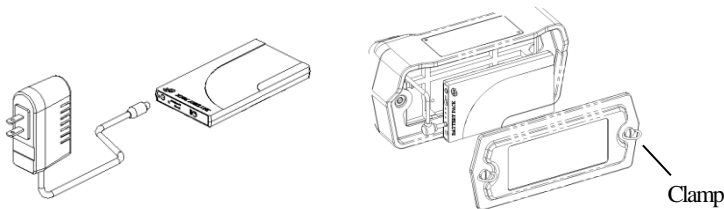

(2) Method of exchange battery pack

- Turn clamps that exit on both sides of charger to the right in a quarter
- Pull out a battery pack
- Inserting is in reverse

(3) Battery pack specifications

Nominal capacity	4000mAh
Nominal voltage	3.7V

(4) Low battery lamp

In order to prevent the electric discharge, after **LOW BATTERY LAMP** is on, the power will be turned off automatically after about 1~5 hours.
(It's subjected to be changed according to using conditions.)

6. General Functions

(1) Zero function

Use to correct drifted zero value when the scale is unloaded, and motion is not detected. This function works when **ZERO KEY** is pressed, and the **ZERO LAMP** is on.

(2) Setting tare weight function.

Press the **TARE KEY**. Then, the scale will memorize the weight of the tare and will display zero value '0'kg. The **TARE LAMP** will be on.

To escape this function, remove everything from the scale, and press the **TARE or ZERO KEY**. Then, the **TARE LAMP** will be off and this function is terminated.

(3) Hold function (F08 of setting mode must be set to 4)

Automatic hold function

- Press * **KEY** when the scale is empty (Initial zero state).
- The weight display will indicate **Rh on**. **HOLD LAMP** is on.
- After loading a thing, if the weight turns stable then, a display shows - - - - - and average weight will appear.
- The weight of a loaded thing is displayed.
- To escape the automatic hold mode, when zero point is on, press * **KEY**. Then, the message of **RhoFF** is displayed and **HOLD LAMP** is off and normal weighing mode is reverted.

Manual hold function

- Press * **KEY** loading a thing.
- This message of **hoLd** is displayed and sequentially the message of - - - - - is shown with appearing the average weight.
- The weight of a loaded thing is displayed.
- To escape the manual hold mode, remove everything from a hook, or press the * **KEY**. Then, **HOLD LAMP** will be off and the scale changes from a hold mode to a normal mode.

7. Setting Mode

(1) How to enter this mode

Press the **ON/OFF KEY** while pressing the **TARE KEY**.
 Changed values are saved after run to the final menu.

(2) Keyboard



: Used to set up an initial zero value (0).



: Used to move the input value to the left or right by one place.



: Used to increase the setting constant one by one.



: Used to save the value and to move next menu.

(3) Menu

■ F01: Number of scales to be linked wireless (1~9)

Setting Menu	Description
F01-1	Very fast
F01-5	Normal
F01-9	Very slow

■ F02: Weight backup (0,1)

Setting Menu	Description
F02-0	Not used
F02-1	Used

■ F03: Stable condition set of weight (1~9)

Setting Menu	Description
F03-1	Sensitive
F03-5	Normal
F03-9	Insensitive

■ F04: Automatic zero condition (00~99)

Setting Menu	Description
F04-00	No compensation
F04-23	Compensation for gradual change below 1d for 3 sec.
F04-99	Compensation for gradual change below 4.5d for 9 sec.

■ F05: Adjustment the hold speed (1~9)

Setting Menu	Description
F05-1	Very fast
F05-5	Normal
F05-9	Very slow

■ F06: Auto hold (0,1)

Setting Menu	Description
F06-0	Manual
F06-1	Automatic

i F08 of setting mode must be set to 4.

i Refer to “6. General Functions”

■ F07: Initialization hold weight (1~9)

Setting Menu	Description
F07-1	Zero (0)
F07-3	Below 3 division
F07-9	Below 9 division

■ F08: Function * key (0~4)

Setting Menu	Description
F08-0	LCD Type : Back light ON/OFF
F08-1	Data send to PRINTER
F08-2	Data send to PC
F08-3	Use to clear previously added weights.
F08-4	Use as Hold key

■ F09:Item number (Identification number of each Item) (0~9)

Setting Menu	Description
F09-0	Item No.0
F09-5	Item No.5
F09-9	Item No.9

■ F10: Weighing data send format (0~4)

Setting Menu	Description
F10-0	Not used
F10-1	Send the print format by automatically at stable
F10-2	Send the weighing data ¹⁾ by automatically at stable
F10-3	Send the print format by automatically at HOLD
F10-4	Send the weighing data by automatically at HOLD

- ❗ Please select this mode if you used the wireless printer.
- ❗ In case of F10-1/3, the print form data(refer to F11) is send to printer and printer is printing with the print form. At this time, the printer mode of YJ380T must change to the NORMAL MODE.
- ❗ In case of F10-2/4, the 22bytes wireless data is send to printer and printer is printing with the itself format. At this time, the printer mode of YJ380T must change to the KEY MODE.

❗ 22bytes data

Type : EIA-RS-232C

Method : Full-duplex, asynchronous transmission Format

- ① Baud rate : 9600 bps
- ② Data bit: 8, Stop bit: 1, Parity bit: None
- ③ Code : ASCII
- ④ Format (22bytes)

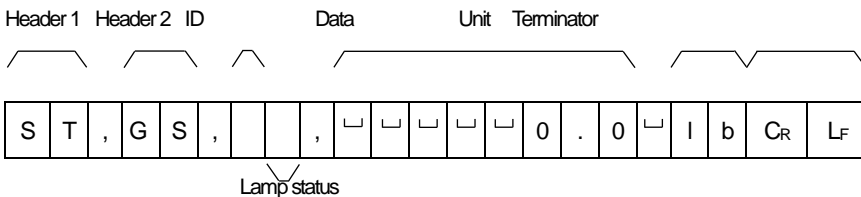

Header 1	ST	Stable weight data (0x53) (0x54)
	US	Unstable weight data (0x55) (0x53)
	OL	Overload (0x4F) (0x4C)
	HD	Hold weight data (0x48) (0x44)
Header 2	GS	Gross data (0x47) (0x53)
	NT	Net data (0x4E) (0x54)

ID	Command address ID is selected in F02 (If ID is 1, 0x31 is sent)							
Lamp Status	Bit7	Bit6	Bit5	Bit4	Bit3	Bit2	Bit1	Bit0
	1	Stable	1	Hold	1	Net	Tare	Zero
Data	Example 1) 13.5 lb ' ',' ',' ',' ','1','3',' ','5' Example 2) 135 lb ' ',' ',' ',' ',' ',' ','1','3',' ','5',' ',' Example 3) -13.5 lb '- ',' ',' ',' ',' ','1','3',' ','5',' ','							
Unit	Kg	(0x6B) (0x67)						
	g	(0x20) (0x67)						
	lb	(0x6C) (0x62)						
Terminator	CR LF	(0x0D) (0x0A)						

■ F11: Print form (0,1)

Setting Menu	Description
F11-0	Form 0 (Data and time, serial No., Item No., weight)
F11-1	Form 1 (Data and time, weigh No., Item No., weight)

❗ The serial number is not saved.

[FORM 0]

2013.10.13 12:00
SN_001, ID_9, 25 lb

[FORM 1]

2013.10.13 12:00
012, ID_9, 131 lb

■ F12: Print line feed (0~9)

Setting Menu	Description
F12-0	1 line feed after printing
F12-5	6 line feed after printing
F12-9	10 line feed after printing

■ F13: Initialization of number measured daily (weigh No.) (0,1)

Setting Menu	Description
F13-0	Maintain current number
F13-1	Initialization (starting from No.1)

❗ Maximum of number is 999, and if it exceeds the number is initialized to 1.

■ F14: Stream wireless mode (0~2)

Setting Menu	Description
F14-0	Not used
F14-1	ZigBee communicate with CRD series and CRC-100
F14-2	ZigBee communicate with CRC-200 dongle

❗ In case of F14-2, refer to the 22bytes data format.

■ F15:Back light mode(0~2)

Setting Menu	Description
F15-0	Manual ON/OFF
F15-1	Automatic ON/OFF (Weighing : ON / Zero : OFF)
F15-2	Always ON

■ F16:Back light brightness level control (1~9)

Setting Menu	Description
F16-1	10%
F16-5	50%
F16-9	100%

8. Test Mode

(1) How to enter this mode





Press the **ON/OFF KEY** while pressing the **ZERO KEY**.

(2) Menu

■ TEST 1: Display test

Display	Description
	TEST 1 runs automatically and a display is on. If press ENTER KEY , move into next menu.

■ TEST 2: Keyboard test

Key	Display	Description
	1	If you press the key that you want to test, the key number is appeared on the display. If press ENTER KEY , moves into next menu.
	2	
	3	
	4	

■ TEST 3: A/D

Display	Description
	The value is the conversion constant for A/D. The value may be different according to scale models. If press ENTER KEY , move into next menu.





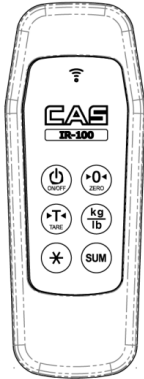

- i** Please check if the displayed number is easily changed with giving force to a hook.
If the displaying number is not changed or remains '0', then it needs the service after sales.

■ TEST 4: Back light test

Display	Description
	If you press the ZERO KEY once, back light turns on and once again, back light is turns OFF. If press ENTER KEY , move into weighing mode.

9. IR Remote Controller



-  : Use to power off the scale
(Power-ON is available only on scale.)
-  : Same as scale's keyboard
-  : Same as scale's keyboard
-  : Same as scale's keyboard
-  : Same as scale's keyboard
-  : Used to add weights.

If press a **SUM KEY**, the sum of weights is displayed.
 After that, about 2 sec later, a weighing mode is reverted.
 Weight of less than 5 digits is not summed.
 Maximum of sum weights is 99999, and if it exceeds
 the weights is initialized to zero.

Type	Infrared
Available Distance	6 m ~ 10 m
Available Angle	60°
Power	3V (1.5V AA 2 EA)

10. Wireless Specification (F model)

“F” model is communicates with our wireless display and controller.
 If you are using a wireless dongle, you can communicate with PC and printer.

RF frequency range	2400 ~ 2483.5 MHz
Output power	Max. 4dBm
Channel width	2 MHz
Frequency offset	< ±30ppm
Transmit data rate	250Kbps,500Kbps
Receiver sensitivity	-99dBm (PER <1%)
Maximum input level	0dBm
RF In/out impedance	50 ohm (TXRF, RXRF)
Spurious(2nd harmonics)	< -30dBm
Radio link effective range	Approx. 100M (Open space)

11. Real Time Clock (F model)

(1) How to enter this mode

Press the **ON/OFF KEY** while pressing the **ZERO KEY**.

(2) Keyboard

 : Used to move the input value to the left or right by one place.

 : Used to increase the setting constant one by one.

 : Used to save the value and to move next menu.

(3) Menu

Display	Description
YERr	Year input readiness.
20 14	Modify the year by pressing the numerical keys and press ENTER key
DATE	Month & date input readiness.
10 13	Modify the date by pressing the numerical keys and press ENTER key
TIME	Time input readiness.
18 00	Modify the time by pressing the numerical keys and press ENTER key
End	The end

12. Real Time Clock (F model)

Step	Operation & Description
1	<p><i>How to enter the pairing mode</i></p> <p>1) CCB crane scale When the display is off, press ON/OFF key while pressing * key. When "t=40 f"(Firmware version) is displayed, press kg/lb key. Then, "rF5Et" is displayed.</p> <p>2) CRD-F wireless display Press the ON/OFF key to power on and immediately press kg/lb key. And press the kg/lb key again. Then, "rF5Et" is displayed.</p> <p>3) CRC-100 controller When the display is off, press ON/OFF key while pressing ENTER key. When "t=60 f"(Firmware version) is displayed, press3 key. Then, "rF5Et" is displayed.</p> <p>4) CRC-200 wireless dongle Press the SET KEY for the 5 seconds with the power on that connected. Then, the green light is blinking.</p>
2	<p><i>Pairing</i> When "rF5Et" is displayed at both products, if you press * key of CCB crane scale, pairing will finish.</p> <p> Please check "End" message at both products. (CRC-200: green light will be turn on) If ending message is not appear, please repeat the pairing.</p>

13. Check Message

EH001

Data in an internal storage value are erased owing to any electronic impact.
Please contact us to resolve this technical problem.

EH002

Something wrong in a Load cell connection or in an A/D conversion.
Please contact us to resolve this technical problem.

EEEE

When a thing is over-weighed within the maximum weight value, the error message is displayed.

Do not weigh the thing whose the limit of a maximum weight value is exceeded.

If a load cell is broken, then the load cell has to be replaced.

MEMO



MEMO

CCB SERIES

Crane Scale



CAS BLDG., #1315, YANGJAE-DAERO,
GANGDONG-GU, SEOUL, KOREA

TEL_ 82 2 2225 3500

FAX_ 82 2 475 4668

www.globalcas.com