

AD-4401

Weighing Indicator

Instruction Manual

1386-2A-IE

AND
A&D WEIGHING
...Clearly a Better Value

1555 McCandless Drive, Milpitas, CA 95035
Tel: (800) 726-3364 / (408) 263-5333 * Fax: (408) 263-0119
Fax-on-Demand: (800) 726-7099, Press 2 * Website: www.andweighing.com
Email: scales@andweighing.com

© 1998 A&D Company Ltd. All rights reserved.

No part of this publication may be reproduced, transmitted, transcribed, or translated into any language in any form by any means without the written permission of A&D Company Ltd.

The contents of this manual and the specifications of the instrument covered by this manual are subject to change for improvement without notice.

CONTENTS

CHAPTER 1 GENERAL DESCRIPTION	3
CHAPTER 2 SPECIFICATIONS	4
2-1 A/D CONVERTER BLOCK.....	4
2-2 DIGITAL BLOCK.....	4
2-3 GENERAL SPECIFICATIONS.....	4
2-4 ACCESSORIES	5
2-5 FRONT PANEL	6
2-6 REAR PANEL	10
CHAPTER 3 INSTALLATION AND CONNECTIONS	11
3-1 ENVIRONMENT.....	11
3-2 POWER SUPPLY	11
3-3 LOAD CELL.....	12
CHAPTER 4 OPERATION	13
4-1 OPERATION MODE.....	13
4-2 CONFIRMATION OF OPERATIONS	14
4-3 SETTING A SETPOINT	15
CHAPTER 5 CALIBRATION.....	18
5-1 GENERAL DESCRIPTION.....	18
5-2 ACTUAL LOAD CALIBRATION (CAL SET).....	19
5-3 CALIBRATION RELATED FUNCTIONS.....	20
5-4 CALIBRATION ERRORS	24
5-5 INITIALIZATION OF ALL THE DATA.....	24
CHAPTER 6 GENERAL FUNCTIONS.....	25
6-1 BASIC CAPABILITIES RELATED.....	26
6-2 WEIGHING SEQUENCE RELATED.....	28
6-3 CONTROL I/O INPUT RELATED.....	30
6-4 CONTROL I/O OUTPUT RELATED.....	30
6-5 STANDARD SERIAL OUTPUT RELATED.....	31

CHAPTER 7 WEIGHING SEQUENCE	32
7-1 WEIGHING SEQUENCE	32
7-2 CUSTOMER PROGRAMMED CONTROL MODE.....	33
7-3 BUILT-IN AUTOMATIC PROGRAM MODE	35
7-5 CHECK WEIGHING MODE	43
7-6 COMPARISON WEIGHT.....	51
7-7 AUTO PRINT.....	51
7-8 AUTOMATIC ACCUMULATION	51
7-9 AUTOMATIC FREE FALL COMPENSATION	52
7-10 FUZZY AUTOMATIC FREE FALL COMPENSATION.....	52
CHAPTER 8 INTERFACE	53
8-1 CONTROL I/O.....	53
8-2 SETPOINT	56
8-3 STANDARD SERIAL OUTPUT (SER. OUT)	57
CHAPTER 9 OPTIONS.....	60
9-1 OP-01 PARALLEL BCD OUTPUT	60
9-2 OP-03 RS-422/-485 INTERFACE	62
9-3 OP-04 RS-232C INPUT/OUTPUTS	64
9-4 OP-05 SETPOINT UNIT	70
9-5 OP-07 ANALOG OUTPUT.....	73
CHAPTER 10 MAINTENANCE	74
10-1 CHECK MODE	74
10-2 INITIALIZATION.....	76
CHAPTER 11 SETTING LISTS	77
11-1 GENERAL FUNCTIONS	77
11-2 CALIBRATION RELATED FUNCTIONS	83
APPENDIX DIMENSIONS	85
AD-4401	85
OP-05.....	85

CHAPTER 1 GENERAL DESCRIPTION

The AD-4401 is a compact-weighing indicator equipped with high-performance A/D conversion and general-purpose capabilities. It has the following features.

User-friendly cabinet design

- Small DIN size (panel dimensions: 138+1.0/-0 x 68+0.7/-0 mm) easy to mount in a control cabinet.
- Splash-proof front panel.

High-performance A/D Converter

- High-speed sampling, 100 times/second.
- High resolution, 1/16,000.
- High sensitivity, 0.3 μ V/D.

Digital Span Capability

- Capable of calibration by inputting a mV/V value without an actual load.
- Capable of directly reading a load cell output (mV/V), for easy installation and maintenance.
- Replaceable without re-calibrating with an actual load in case of trouble.

Flexible Digital Filter allows installation in unstable environments

- Excellent vibration canceling performance.
- Widely covers from high-speed hopper scales to platform scales.

Two-stage Indicators monitoring Tare, Final, and Accumulated Weight values at any time.

Eight Weighing Modes available for wider applications

Capable of being used in a PLC-free hopper system owing to a complete weighing sequence.

- Built-in discharging sequence
- Monitors loading and discharging times
- Supplementary flow capability

Setpoints can be set using RS-232C/422/485 (Optional) as well as the front panel keys or an external thumbwheel switch.

Control I/O providing a selection of the input/ output terminal capabilities and is available for any system.

High-speed, high-accuracy hopper scale based on Fuzzy Automatic Free Fall Compensation.

CHAPTER 2 SPECIFICATIONS

2-1 A/D CONVERTER BLOCK

Input sensitivity	0.3 μ V/D or more	
Zero correction range	0 to 20 mV (0 to 2mV/V)	
Load Cell Excitation	10VDC +/- 5 %, 230 mA, with remote sensing capability (Up to eight 350 ohm load cells can be connected)	
Temperature coefficient	Zero point	$\pm(0.2 \mu\text{V} + 0.0008 \% \text{ of Dead Load }) / ^\circ\text{C typ}$
	Sensitivity	$\pm 0.0008 \% / ^\circ\text{C typ}$
Non-linearity	$\pm 0.01\%$ FS	
Maximum measurement voltage	32 mV (3.2 mV/V)	
Internal resolution	Approx. 1/1,000,000	
Maximum display resolution	16000	
Sampling speed	100 times/second	

2-2 DIGITAL BLOCK

Display element	Fluorescent display tube (Display color: Cobalt blue, Status display in orange) Display types; 1) Main display section: 7-segment 7-digit, Character height: 13 mm 2) Subdisplay section: 7-segment 8-digit, Character height: 7 mm 3) Status display: Up to 14 "-" marks are displayed
Main display section	Switchable between net weight and gross weight Display range: 0 to 16000D (Minimum division D is selectable out of 1, 2, 5, 10, 20, and 50) Decimal point: Capable of setting 10^1 , 10^2 , 10^3 , and 10^4 digits Overflow display: All digits turned off ("-" is displayed in the highest digit in case of negative polarity) Units: g, kg, t (international version), kg, lb (USA version).
Subdisplay section	Tare, final, and accumulated weight values are selectable by the function. Also available for Calibration setting, function setting, and error display.
Status display section	Zero point, stability, gross, net, hold, <input type="checkbox"/> , alarm, final, free fall, preliminary, optional preliminary, overlimit, underlimit, and zero band depending on the weighing mode
Operational Keys	SETPPOINT, ZERO, TARE, NET/GROSS, F, ENTER, OPR/STB, CAL

2-3 GENERAL SPECIFICATIONS

EXTERNAL INPUT/OUTPUT

Control I/O	Input	6 points (6 bits, 1 COM) Dry contact or open collector signal Insulated from an internal circuit by an optocoupler. *Terminal functions selectable by the function settings
	Output	8 points (8 bits, 1 COM) Open collector output (NPN transistor) Rating: 30 V DC, 50 mA (Resistance load) Saturation voltage between a collector and emitter: 1.2 V or less Insulated from an internal circuit by an optocoupler. *Terminal functions selectable by the function settings
Standard serial output	Output for our peripheral device connection (0 to 20 mA current loop signal)	
Setpoint	Changes setting of each setpoint, using a thumbwheel switch. Capable of connecting an OP-05 setpoint unit in addition to the thumbwheel switch. Input	

WEIGHING CAPABILITIES

Zero point correcting capability (Zero)	Clears the gross to zero in compliance with a command from the ZERO keys, Control I/O, etc. Capable of enabling or disabling operations at unstable time. Zero correction value is backed up by a battery. Adjustable range: Can be freely set within 1 to 30 % of weighing capacity.
Zero tracking capability	Detects gross zero point drift and performs zero correction automatically. Tracking time: 0.0 to 5.0 (seconds)... A range can be set freely Tracking width: 0.0 to 4.5 (D) ... A range can be set freely
Tare subtracting function	Clears the net weight zero in compliance with a command from the TARE key, Control I/O, etc. Capable of enabling or disabling operations at unstable time or negative weight time. The battery backs up a tare value. Adjustable range: gross \leq Weighing capacity
Stability detecting capability	When a weighed value fluctuation amount per sampling enters a set width within a set time, a stability mark is illuminated, judging it a stable condition. Capable of confirming stability through Control I/O. Stability detection time: 0.1 to 5.0 (seconds) ... A range can be set freely Stability detection width: 0 to 9 (D) ... A range can be set freely
Digital filter function Integrating capability	Two digital filters connected in series Cutoff frequency range: 0.7 to 11 (Hz)
Integrating capability	Integrates the net weight automatically or manually. An accumulated weight and the number of accumulated weighing times are backed up by the battery. Accumulated weight range: 0 to 99999999 Accumulated weighing times range: 0 to 99999999

OVERALL

Power failure countermeasure Data backup method	Zero point correction value, tare value, setpoint, accumulated weight Memory backup by the lithium battery (Approx. 10 years) An alarm indicator lamp is turned on when the battery is running out. Calibration data, each function data Writes into the non-volatile memory(EEPROM).(Up to 10,000 times)
Supply voltage	100 to 120 VAC +10%/-15%, 50 Hz or 60 Hz 200 to 240 VAC +10%/-15%, 50 Hz or 60 Hz
Power consumption	Approx. 30 VA
Working temperature and humidity range	-5 to +40 °C, 20 to 85 % R.H
Mounting method	Panel mounting type
Weight (accessories not included)	Approximately 1.3 kg

2-4 ACCESSORIES

Parts Name	Q'ty	A&D's parts Number	Description
Fuse	1	FS-EAK-1A	EAK-1A (Time lag fuse, 1 A)
Connector for Control I/O	1	J1-361J016-AG	FCN361J016-AG (FUJITSU)
	1	J1-360C016-B	FCN360C016-B (FUJITSU)
Connector for standard serial output	1	JA-TCP0576	TCP0576 (HOSHI ELECTRIC)
Capacity plate	1		N/A
Unit label	1		N/A
Panel mount packing	1		N/A
Terminal block cover	1		N/A
Rubber leg	4		N/A

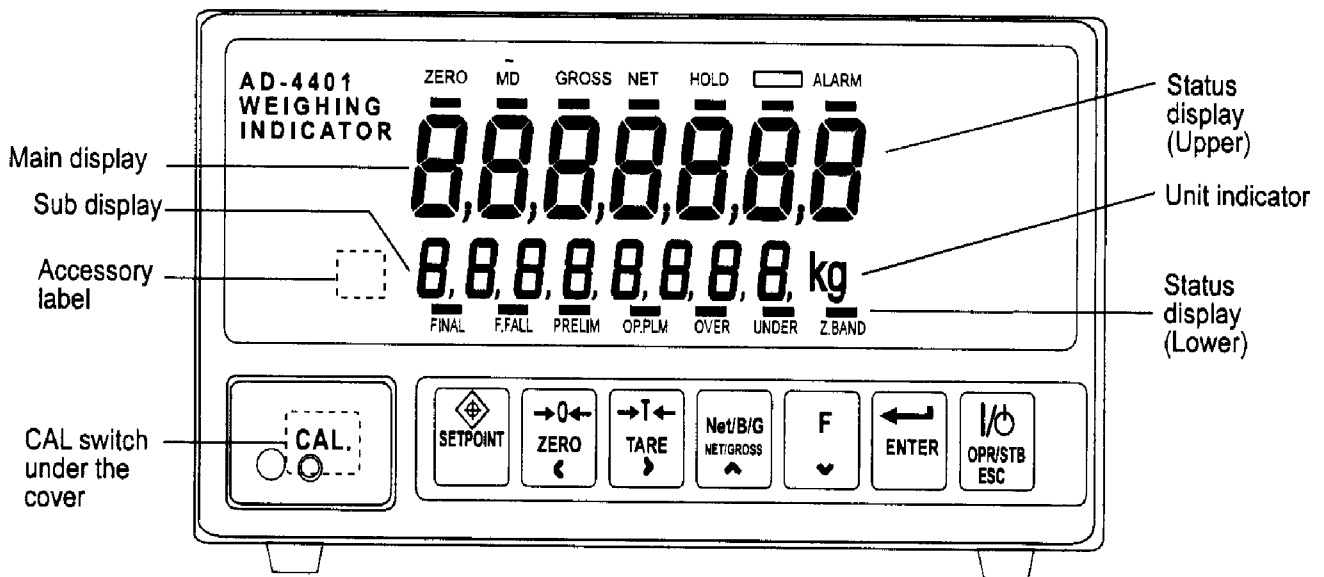

2-5 FRONT PANEL

MAIN DISPLAY SECTION

A 7-digit 7-segment display. Displays the gross, net weight, etc.

SUB DISPLAY SECTION

An 8-digit 7-segment display. The display content can be selected using the "general functions." The display content is indicated by attaching an accessory label.

STATUS DISPLAY SECTION (UPPER)

The upper "-" mark indicates the status of the weight value.

[ZERO]

Illuminated when the gross is located at the center of the zero point (center zero).

[MD]

Illuminated when the weight value is unstable. The motion condition can be changed using a "calibration related function."

[GROSS]

Illuminated when the displayed weight is the gross weight.

[NET]

Illuminated when the displayed weight is the net weight.

[HOLD]

Illuminated when the weight display is being held. Either normal hold or peak hold can be selected using the "general functions."

[]

This display capability can be changed depending on the application and selected using the "general functions."

[ALARM]

Illuminated in case of zero range error, weighing capacity overflow, or low battery.

STATUS DISPLAY SECTION (LOWER)

The lower "-" mark indicates a comparison result.

In the normal mode, it is illuminated when a setpoint output of an identical name is turned on. In the setpoint setting mode, the "-" mark relevant to the value in the lower numerical display section blinks. Attach an accessory label depending on the weighing mode.

< Normal Batching >

[FINAL]

Blinks while setting the final weight.

Normal batching — Illuminated when the net weight is within a positive range.

[F. FALL]

Blinks while setting the free fall.

Normal batching — Illuminated when the net weight is more than the final weight minus free fall.

Built-in-automatic program mode — Illuminated during dribble flow.

[PRELIM]

Blinks while setting the preliminary.

Normal batching — Illuminated when the net weight is more than the final weight minus preliminary.

Built-in-automatic program mode — Illuminated during medium flow.

[OP PLM]

Blinks while setting the optional preliminary.

Normal batching — Illuminated when the net weight is more than the final weight minus optional preliminary. Built-

in-automatic program mode — Illuminated during full flow.

[OVER]

Blinks while setting the overlimit.

Illuminated when the net weight is more than the final weight plus overlimit.

[UNDER]

Blinks while setting the underlimit.

Illuminated when the net weight is less than the final weight minus underlimit.

[ZERO BAND]

Blinks while setting the zero band.

Illuminated when the gross weight is less than the zero band.

< Loss-in-weight >

Attach a label that has "OPTIONAL PRELIMINARY" replaced by "FULL." The other operations are the same as normal batching.

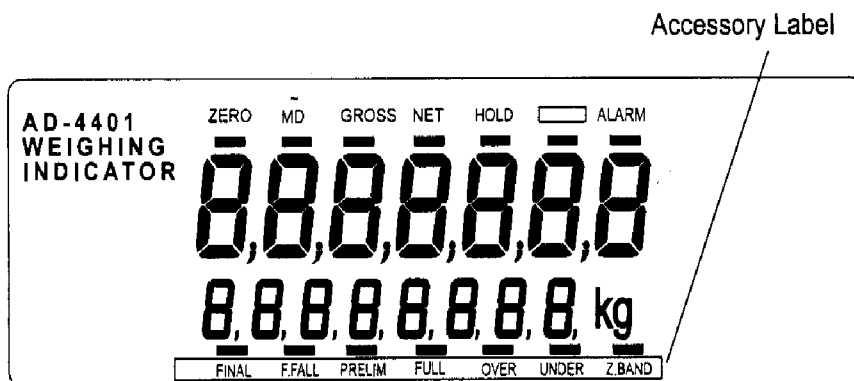

[FULL]

Blinks while setting the full weight./ Illuminated when the gross weight is more than the full weight.

< Check Weighing >

The meaning of each “-” mark differs completely. Attach a different accessory label. There are four kinds of Check Weighing.

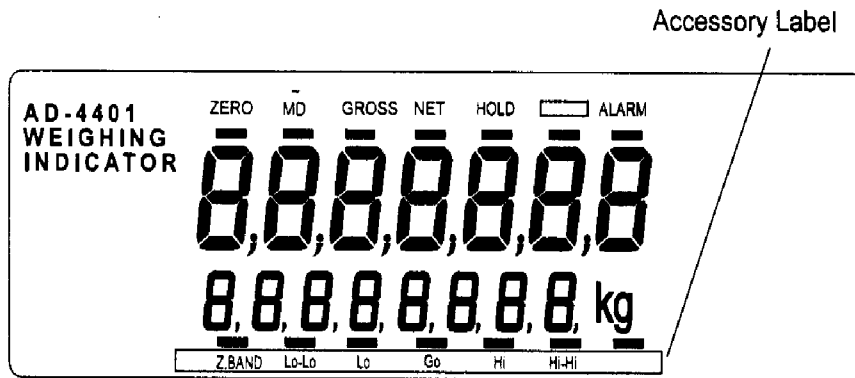

[Z.BAND]

Illuminated when the gross weight is less than the zero band.

[Lo-Lo]

Blinks while setting the Lo-Lo.

Illuminated when the comparison result output, Lo-Lo, is turned on.

[Lo]

Blinks while setting the Lo limit.

Illuminated when the comparison result output, Lo, is turned on.

[Go]

Blinks while setting a reference value.

Illuminated when the comparison result output, Go, is turned on.

[Hi]

Blinks while setting the Hi limit.

Illuminated when the comparison result output, Hi, is turned on.

[Hi-Hi]

Blinks while setting the Hi-Hi limit.

Illuminated when the comparison result output, Hi-Hi, is turned on.

KEY SWITCHES

[CAL]

The key used to enter the calibration mode. A cover is provided so that this key can not be operated if used in a certified commercial application. In order to prevent erroneous operation, attach and seal the cover.

[SETPOINT]

The key used to set a setpoint. If this key is pressed together with the [ENTER] key, you will enter the "general function" mode.

[ZERO] ([<])

The key used for zeroing. A zeroing condition can be set with the "calibration related functions." While inputting a number, this key is used to shift the blinking digit to the left.

[TARE] ([>])

The key used to subtract the tare. The tare subtraction condition can be set with the "calibration related functions."

While inputting a number, this key is used to shift the blinking digit to the right.

If the [ON/OFF] key is pressed together with this key in the OFF mode, the zero compensation value and the tare value will be cleared.

[GROSS/NET] ([^])

The key used to switch the weight display from gross weight to net weight and vice versa. While inputting a number, pressing this key will increase the number of the blinking digit by one.

[F] ([V])

The capability of this key can be changed depending on the application. The following capabilities can be selected using the "general functions."

No capability (Setting upon shipment)	Emergency stop
Print command for manual print	Clear to zero
Hold	Clear tare
Batch Start	Clear accumulation

While inputting a number, pressing this key decreases the number of the blinking digit by one.

[ENTER]

While inputting a number, pressing this key writes that number into memory.

[OPR/STB] ([ESC])

The key used to switch from the normal mode (ON state) to the standby mode (OFF state) and vice versa. In the

standby mode, all displays and external inputs/outputs are turned off and a circle (O) appears in the unit display section.

While inputting a number, this key serves as the [ESC] (Escape) key.

TOP OF FRONT PANEL

The top of the front panel has a concave area for attaching a weighing capacity nameplate.

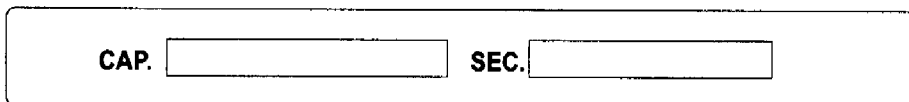

2-6 REAR PANEL

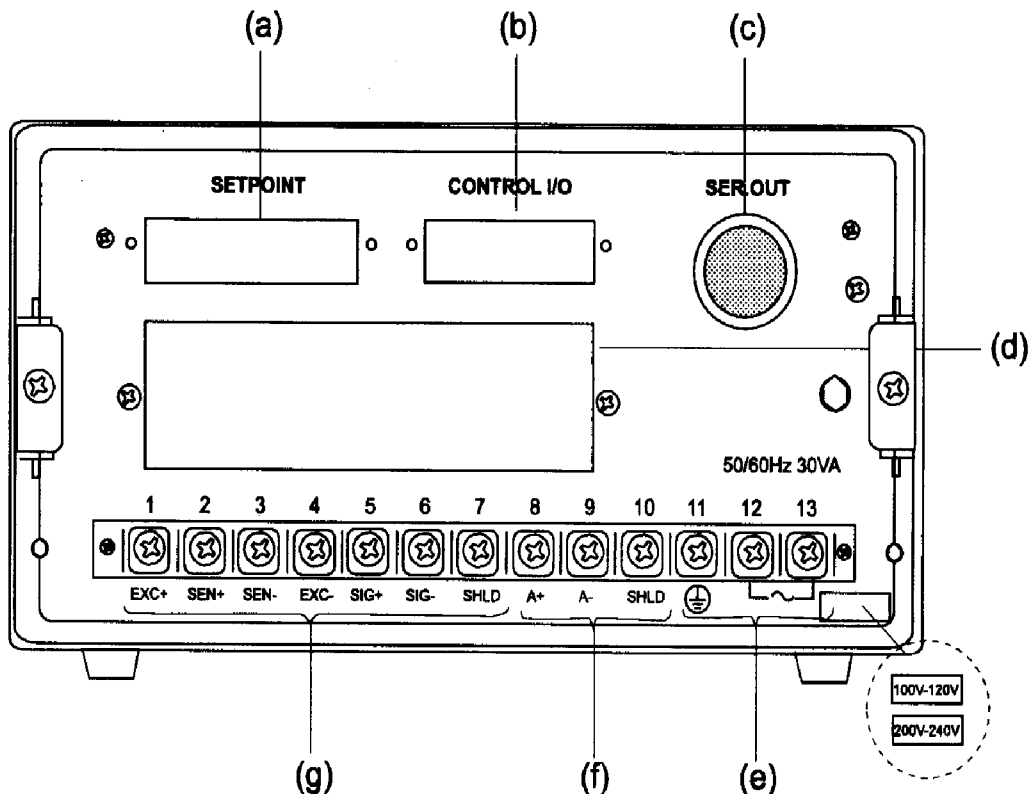

- (a) Connects the thumbwheel switch or setpoint unit (OP-05) to set a setpoint required for a weighing sequence. See 8-2 and 9-4.
- (b) Inputs/outputs the signals such as tare subtraction input, each loading output required for the weighing sequence. The capability of each terminal can be changed freely. See 8-1.
- (c) Provides an output for the standard serial interface (current loop).
- (d) One of the following options can be attached;
OP-01 BCD output, OP-03: RS-422/-485 input/output, OP-04: RS-232C input/output
- (e) Connects to the power source. Confirm the description on the supply voltage label. See 3-2.
- (f) Provides an analog output if option OP-07, analog output, is attached. Use a shielded cable for wiring.
- (g) Connects to the load cell. Use a shielded cable for wiring. See 3-3.

Be sure to attach a cover to the terminal block on the rear panel in order to prevent an accident.

CHAPTER 3 INSTALLATION AND CONNECTIONS

This chapter describes the installation environment, and connections to the power terminals and load cell connector. For other external inputs/outputs, see their relevant descriptive chapters.
 Control I/O, Setpoint (SETPOINT), Standard serial output (SER. OUT) — Chapter 8
 Options — Chapter 9

3-1 ENVIRONMENT

This is a precision electronic instrument. Handle it very carefully. The working temperature range is -5 to +40°C. Install it in a place free from the direct sunlight. When water drops may splash over the instrument, attach it to a control panel, using the accessory packing. This makes the instrument's front panel splash-proof.

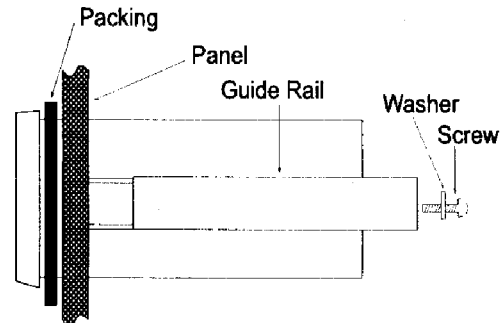

3-2 POWER SUPPLY

- 1) Prior to connecting the power source, read this manual thoroughly.
- 2) Be sure to earth ground the instrument. Use independent grounding if possible. Try not to share grounding with other electric devices that create electrical noise.
- 3) The power source should be either 100 to 120 VAC +10%/-15% specification, or 200 to 240 VAC +10%/-15% specification; with a frequency of 50 or 60 Hz. Use a stable power source free from instantaneous dropout or noise. Sharing a power line could result in malfunctioning.
- 4) The load cell output is very weak. Do not install any noise-generating device near the load cell or the load cell cables.
- 5) Each input/output cable should be shielded and connected to either shield terminal 7 or 10 of the terminal strip on the rear of the indicator. Use of terminal 11 or the indicator body, could induce electrical noise.

Terminal No.	Terminal Function	
1	EXC+	Load cell excitation voltage (+)
2	SEN+	Sensing input (+)
3	SEN-	Sensing input (-)
4	EXC-	Load cell excitation voltage (-)
5	SIG+	Load cell input (+)
6	SIG-	Load cell input (-)
7	SHLD	Shield
8	A+	4 to 20 mA output (+)
9	A-	4 to 20 mA output (-)
10	SHLD	Shield
11	E	FG
12	AC	AC power supply
13	AC	AC power supply

- 6) To change a blown fuse.
 Turn the power off and wait 10 seconds or more. Replace the fuse with the accessory fuse without touching other parts.
 Make sure that no stray material is left in the case, screws, spacer, etc., before closing the case.

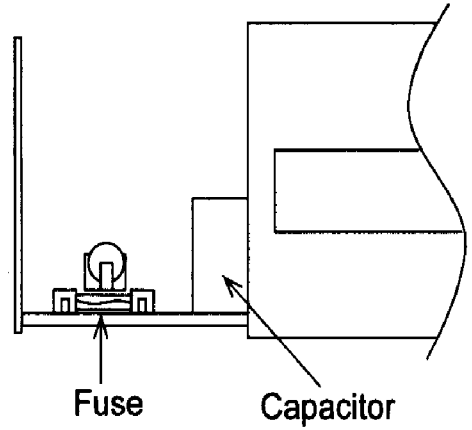

3-3 LOAD CELL

For a load cell cable, the use of a 6 wire shielded cable is recommended in order to reduce weighing error.
 When using a 4 wire cable, connect pin no. 1 to no. 2 (load cell applied voltage + and sensing input +), and pin no. 3 to no. 4 (load cell applied voltage - and sensing input -).

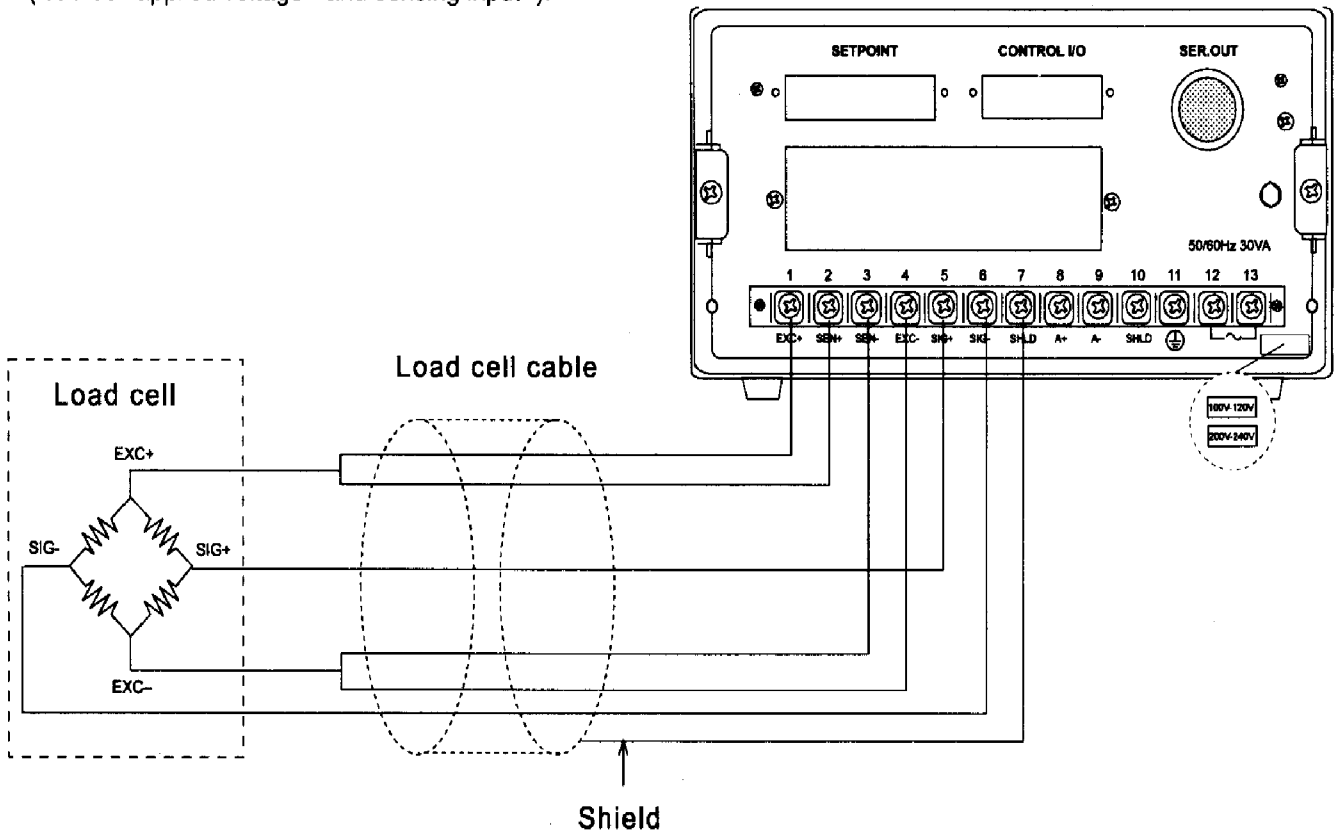

CHAPTER 4 OPERATION

4-1 OPERATION MODE

This instrument has various "modes" in compliance with its operating conditions. Use the keys to change the mode. You can change the mode in the full-line arrow direction. The broken-line arrow direction indicates only an automatic reset after completion of setting or a reset by turning off the power.

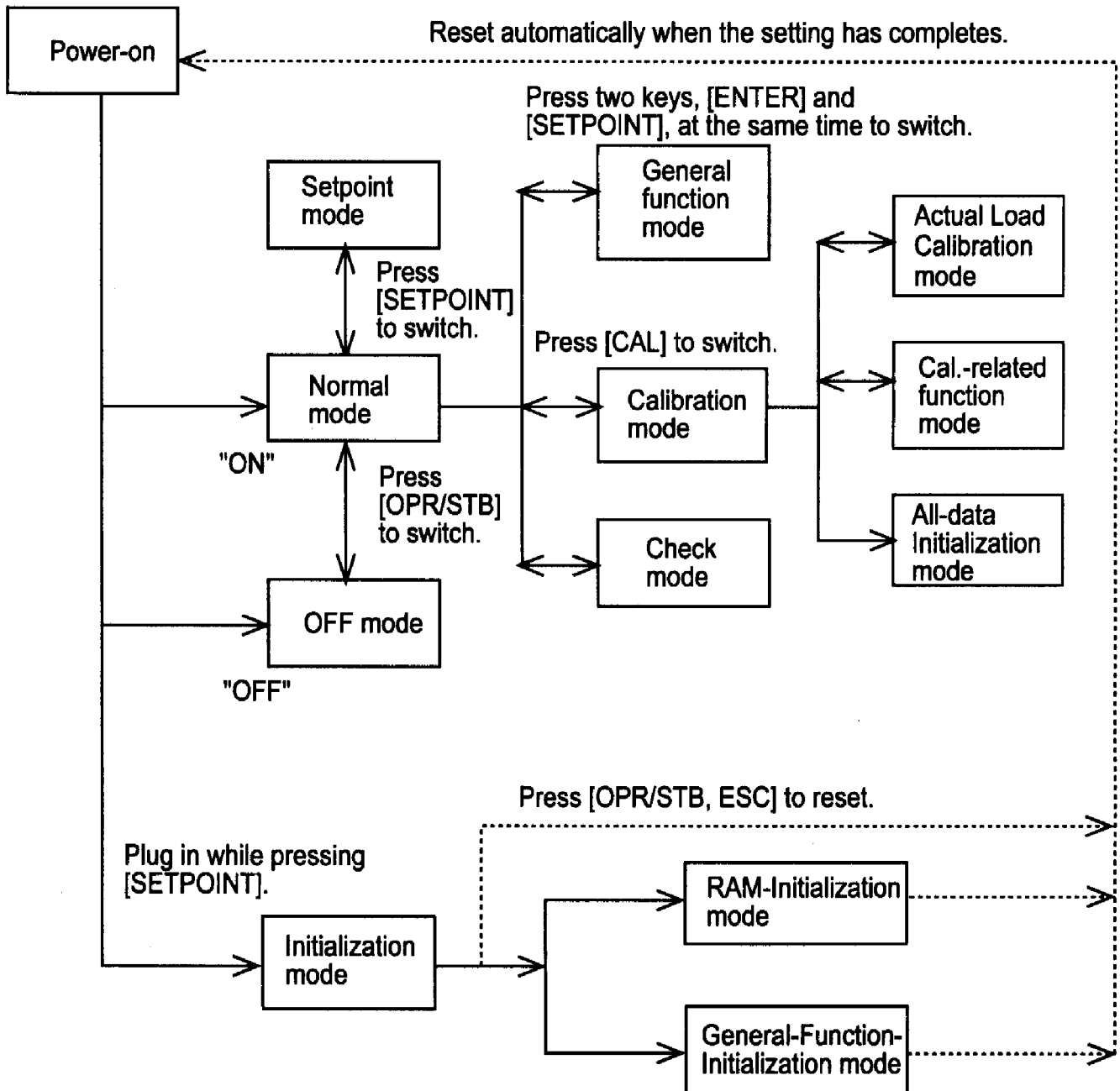

* If powered off in the OFF mode, it is in the OFF mode when powered on next time.

4-2 CONFIRMATION OF OPERATIONS

The following outlines the procedure up to displaying a weight value in order to confirm operations after unpacking. Connect a load cell or load cell simulator to the proper terminals on the rear of the indicator.

TURNING ON THE POWER

* Do load cell wiring before turning on the power.

If the power is turned on in the normal mode, the display unit will be fully illuminated for about 2 seconds, and then, a weight value will be displayed in the main display section. A weight value may not be displayed if calibration has not been performed yet.

When only a circle (O) is displayed in the unit display section, the indicator is in the OFF mode. Press the [OPR/STB] key.

CALIBRATION

The following outlines on how to calibrate the indicator. For details, see Chapter 5.

- Step 1 Remove the cover from the calibration switch located at the lower left of the front panel and press the [CAL] key (found inside). "CAL" is displayed to inform you that the indicator is entering the calibration mode.

Note: When calibration is not required, press the [ESC] key and the indicator will return to the normal mode.

- Step 2 Press the [ENTER] key. The indicator has entered the calibration mode and "CAL SE1" is displayed. The right most digit starts blinking.
- Step 3 To select the desired operation, use the [^] or [v] key, Press the [^] key, "CAL Fnc" is displayed.
- Step 4 Press the [ENTER] key. The indicator enters the calibration related function mode. The main display section displays "CALF-01" and the sub-display section displays its set value. CALF-01 indicates the setting of the unit.
- Step 5 Select the function number you want to set, using the [^] or [v] key. The lower display section displays the set value for the selected function. CALF-02 indicates the setting of a decimal point position.
- Step 6 In this example, you change the decimal point position to the 10¹ digit. Press the [ENTER] key. The Subdisplay section now starts blinking.
- Step 7 Press the [^] key. The Subdisplay section displays "1".
- Step 8 Press the [ENTER] key. The main display section starts blinking again and you are returned to Step 5, the selection of a function number.
- Step 9 Press the [ESC] key. The main display section starts blinking again and the settings so far are saved in the EEPROM.
This state is the same as in Step 3. Press the [ESC] key again twice. The indicator will return to the normal mode.
- Step 10 Subsequently, calibrate with an actual load. Press the [ENTER] key. The main display section displays "CAL 0."
- Step 11 With no weight placed on the system and press the [ENTER] key after the motion-detect mark is turned off. The Subdisplay section displays "—" for about 2 seconds.

- Step 12 The main display section displays "CAL SPn", the Subdisplay section displays a weight value (current weighing capacity, set value for CALF-04), and the lowest digit of the weight value blinks. Adjust to the calibration weight value that you have on hand, using the [<], [>], and [V] keys.
- Step 13 Place the weight on the system, and press the [ENTER] key after the motion-detect mark is turned off. The Subdisplay section displays "—" for about 2 seconds.
- Step 14 The main display section displays "CAL End." If "C ErrXX" has been displayed so far, there is an error taking place. See 5-5.
- Step 15 Press the [ESC] key. The main display section displays "CAL SET" and the actual load calibration data is saved in the EEPROM.
- Step 16 This state is the same as in Step 3. Press the [ESC] key again twice. The indicator will return to the normal mode.

The normal mode is restored and the weight value is displayed.
 After calibration is finished, be sure to attach the [CAL] key cover.

4-3 SETTING A SETPOINT

The setpoint refers to a weight setting such as a target weight or final weight required for a weighing sequence. The following describes how to set the setpoint. For the details of the thumbwheel switches, see 8-2.

The following four methods are available for setting the setpoint:

1. Setting with the key switches (Thumbwheel switch not required)
2. Setting with a 5-digit thumbwheel switch
3. Setting with a 16-digit thumbwheel switch or OP-05 setpoint unit
4. Setting with the RS-232C/-422/-485 (See 9-2, 9-3)

Select one of the above-mentioned methods in the "setpoint read mode (SPF-01)" of the general functions.

All of the setpoint settings are backed up by the memory battery and held even if the power is turned off.

The setpoint differs depending on the weighing mode. When the weighing mode (CALF-14) is changed, attach a relevant accessory label onto the specified area of the front panel. The following describes the initial setting state and no label is required to be attached.

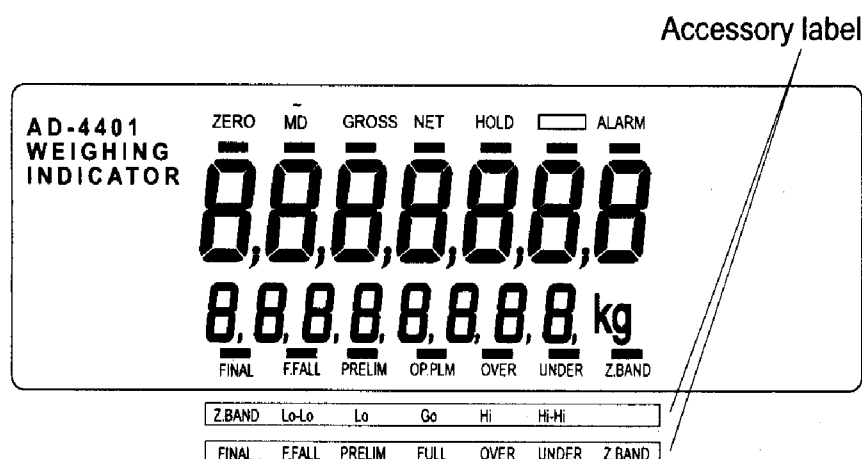

SETTING WITH THE KEY SWITCH (SPF-01 = 0)

This method sets the setpoint using only the keys on the front panel.

- Step 1 Press the [SETPOINT] key in the normal mode. The indicator will switch to the setpoint setting mode. The "-" mark above FINAL in the Subdisplay section blinks and a final value is displayed.
- Operating the [SETPOINT] key allows you to refer to other setpoints.
 - Operating the [<] or [>] key also allows you to refer to the setpoint.
 - If the [SETPOINT] key is pressed while the right end (ZERO RANGE) is being displayed, you will be returned to the normal mode.
 - Pressing the [ESC] key returns you to the normal mode at any time.
- Step 2 Press the [ENTER] key. The blank digits of the Subdisplay section are filled with the character "0". A cursor appears at the lowest digit and the right most digit starts blinking.
- Step 3 Rewrite the set value, using the [<], [>], and [V] keys
- In this example, the set value has not been saved internally.
 - When you want a negative set value in Check Weighing, and so on, move the cursor to the left end and use the [V] key to decrement 0.
- Step 4 Press the [ENTER] key. The set value is saved internally. Surplus zeros and the cursor disappear.
- This state is the same as in Step 1.
 - To return to the normal mode, press the [ESC] key.

SETTING WITH A 5-DIGIT THUMBWHEEL SWITCH (SPF - 01 = 1)

In the normal mode, the 5-digit thumbwheel switch is read as the final value in real time. Using this thumbwheel switch, you can set other setpoints.

When the setting of the minimum graduation (CALF-03) is 10 or more, the value of the thumbwheel switch is multiplied by 10 when saved.

- Step 1 Press the [SETPOINT] key in the normal mode. The indicator will switch to the setpoint setting mode. The "-" mark above FINAL in the Subdisplay section blinks and a final value is displayed.
- Operating the [SETPOINT] key allows you to refer to other setpoints.
 - Operating the [<] or [>] key also allows you to refer to the setpoint.
 - If the [SETPOINT] key is pressed while the right end (ZERO RANGE) is being displayed, you will be returned to the normal mode.
 - Pressing the [ESC] key returns you to the normal mode at any time.
- Step 2 In this example, a free fall is set. Press the [SETPOINT] key. The "-" mark above FREE FALL blinks and a free fall value is displayed.
- Step 3 Change the thumbwheel switch to the desired value and press the [ENTER] key. The value of the thumbwheel switch is saved internally as the free fall.
- This state is the same as in Step 1. To return to the normal mode, press the [ESC] key.

Note: Prior to returning to the normal mode, be sure to return the value of the thumbwheel switch to the final value.

SETTING WITH THE 16-DIGIT THUMBWHEEL SWITCH (SPF - 01 = 2)

This method assigns an exclusive thumbwheel switch to each setpoint. Some setpoints are set with the front panel keys without using the thumbwheel switch.

Assignment of the thumbwheel switch and the front panel keys differs depending on the weighing mode (CALF-14). Since the setpoint assigned to the thumbwheel switch is read in real time, it can be referred to by key operation, but it cannot be altered. The following shows assignment of the setpoints.

Normal Batching (Customer Programmed Control Mode) (CALF-14=1)
Normal Batching (built-in Automatic Program Mode) (CALF-14=3)

For the thumbwheel switches Final (5 digits), Free Fall (3 digits), Preliminary (4 digits) Over Limit (2 digits), Under Limit (2 digits)

For the key switches Option Prelim, Zero Band

Loss-in-weight (Customer Programmed Control Mode) (CALF-14=2)
Loss-in-weight (built-in Automatic Program Mode) (CALF-14=4)

For the thumbwheel switches Final (5 digits), Free Fall (3 digits), Preliminary (4 digits) Over Limit (2 digits), Under Limit (2 digits)

For the key switches Full, Zero Band

Check Weighing Mode 1 (CALF-14=5)
Check Weighing Mode 2 (CALF-14=6)

For the thumbwheel switches Lo (5 digits), Hi (5 digits)
For the key switches Zero Band, Lo-Lo, Hi-Hi

Check Weighing Mode 3 (CALF-14=7)

For the thumbwheel switches Lo-Lo (4 digits), Lo (4 digits), Hi (4 digits), Hi-Hi (4 digits)
For the key switches Zero Band
Check Weighing Mode 4 (CALF-14=8)

* For setting with the front panel keys, see "Setting with the Key Switches (SPF - 01 = 0)."

* When the minimum graduation setting (CALF-03) is 10 or more, 10 will multiply the value set with the thumbwheel switch.

CHAPTER 5 CALIBRATION

5-1 GENERAL DESCRIPTION

In the calibration mode, you carry out an operation, which associates a load cell output voltage with a weight value, and operations directly related to weighing. There are the following four kinds.

Calibration Modes:	Actual load calibration	
	Calibration related functions	Digital span
	Initialization of all data	

Actual load calibration	<p>This is calibration with weights.</p> <p>[Zero calibration] The zero point is measured with no weight loaded.</p> <p>[Span calibration] The full weighing capacity point is measured with a calibration weight loaded.</p> <ul style="list-style-type: none"> • Once in the calibration mode, the tare value and zero compensation value are cleared automatically.
Calibration related functions	They set the data directly related to weighing as well as basic constants for the weighing instrument such as minimum graduation, weighing capacity, and so on.
Digital span	<p>The zero point and span are set by entering the load cell output (mV/V) using the keys. No calibration weight is loaded. (CALF-15 ~ CALF-17 of the Calibration related functions.)</p> <ul style="list-style-type: none"> • [Zero calibration] Enter the load cell output at the zero point. • [Span calibration] Enter the difference of the load cell output between at the full weighing capacity and at the zero point. • Weight to Span calibration Relate the input voltage at [Span calibration] above with weight to be displayed.
Initialization of all data	All the data of the EEPROM and RAM are initialized.

- **All the data set in calibration is saved in the EEPROM and held even if the backup battery is fully discharged.**
- **Do the all load cell wiring before turning the power on. Calibration may be failed if wired after turned on.**

5-2 ACTUAL LOAD CALIBRATION (CAL SET)

The zero point and span are calibrated using a calibration weight. When making calibration for the first time, it is necessary to set the unit, decimal point position, minimum division, and capacity in advance, using the calibration-related functions mentioned in 5-3.

In order to avoid influence by temperature drift; carry out this calibration 10 minutes or more after turning on the power.

Step 1 Remove the cover from the calibration switch located at the lower left of the front panel and press the [CAL] key (found inside). "CAL" is displayed to inform you that the indicator is entering the calibration mode.

- **Note: When calibration is not required, press the [ESC] key. The indicator will return to the normal mode.**

Step 2 Press the [ENTER] key. The indicator has entered the calibration mode and "CAL SET" is displayed. The right most digit starts blinking.

ZERO CALIBRATION

Step 3 Press the [ENTER] key. The main display section displays "CAL 0."

When you want to monitor the current weight value, press the [SETPOINT] key. The Subdisplay section displays the value. Pressing the [SETPOINT] key again erases this display.

When zero calibration is not necessary, press the [F] key. The indicator will go to span calibration (Step 5).

Step 4 With no weight placed on the system, press the [ENTER] key after the motion-detect mark is turned off. The Subdisplay section displays "—" for about 2 seconds.

- **When "C ErrXX" is displayed, there is an error taking place. See 5-4.**

SPAN CALIBRATION

Step 5 The main display section displays "CAL SPn," the Subdisplay section displays the weight value (current weighing capacity, set value for CALF-04), and the lowest digit of the weight value blinks. Adjust to the calibration weight value that you have on hand, using the [<], [>], [^], and [v] keys.

When you want to monitor the current weight value, press the [SETPOINT] key. The Subdisplay section displays the value. Pressing [SETPOINT] again replaces this display with the weight value.

When span calibration is not necessary, press the [ESC] key twice. You are returned to the normal mode.

Step 6 Place the calibration weight on the system and press the [ENTER] key after the motion-detect mark is turned off.. The Subdisplay section displays "—" for about 2 seconds.

- **When "C ErrXX" is displayed, there is an error taking place. See 5-4.**

Step 7 The main display section displays "CAL End."

When you want to readjust the span, press the [F] key. This will allow you to continue span calibration.

Step 8 Press the [ESC] key. The main display section displays "CAL SET" and the actual load calibration data is saved in the EEPROM.

Step 9 This state is the same as in Step 3. Press the [ESC] key once again. The indicator will return to the normal mode and the weight value is displayed.

5-3 CALIBRATION RELATED FUNCTIONS

The calibration related functions are designed to set the basic constants for the indicator. They should be carried out first thing upon installation.

- Step 1 Remove the cover from the calibration switch located at the lower left of the front panel and press the [CAL] key (found inside). "CAL" is displayed to inform you that the indicator is entering the calibration mode.
- Step 2 Press the [ENTER] key. The indicator switches to the calibration mode and "CAL SET" is displayed. The right most digit starts blinking.
- Step 3 Press the [] key. "CAL Fnc" is displayed.
- Step 4 Press the [ENTER] key. The indicator switches to the calibration related function mode. The main display section displays "CALF-01" and the Subdisplay section displays its set value. CALF-01 is the function for the setting of the unit.
- Step 5 Select the function number you want to set, using the [<], [>], [^], and [v] keys. The display section displays a set value for the selected function. In this example, select CALF-02 to set the decimal point position.
- Step 6 In this example; you change the decimal point position to the 10¹ digit. Press the [ENTER] key. The Subdisplay section now starts blinking.
- Step 7 Press the [] key. The Subdisplay section displays "1".
- Step 8 Press the [ENTER] key. The main display section starts blinking again and you are returned to selection of the function number (Step 5).
- Step 9 Press the [ESC] key. "CAL SET" is displayed and the settings so far are saved in the EEPROM.
- Step 10 This state is the same as in Step 3. Press the [ESC] key once again. The indicator is return to the normal mode.

The normal mode is restored and the weight value is displayed.

- **When "Err" is displayed, the value input exceeds the setting range.**
- **When "C ErrXX" is displayed, there is an error taking place. See 5-4.**

CALIBRATION RELATED FUNCTIONS

CALF-	Name	Setting		
		Default	Parameter	Description
01	Weighing Unit	2	0	None
			1	g (International version)
			2	kg (International version and USA version)
			3	t (International version)
			4	lb. (USA version)
02	Decimal Point Position	0	0	None 12345
			1	10 ¹ 1234.5
			2	10 ² 123.45
			3	10 ³ 12.345
			4	10 ⁴ 1.2345
03	Minimum Division	1	1, 2, 5, 10, 20, or 50	Minimum division (increment) for the weight value. Input 1,2, 5, 10, 20, or 50(decimal point ignored).
04	Capacity	16000	0 to 800000	Capacity of the weighing. Weighing is allowed up to this setting + 9D(9 divisions). A weight value beyond this limit is an overflow and not displayed.
05	Zero Range	2	0 to 30	A range of accepting "zero" from the [ZERO] key or Control I/O. Represented in terms of percent(&) with respect to the weighing capacity, centering around the zero calibrated point in calibration. If this is set to 2, "zero" can be accepted within a range of the zero calibrated point +/- 2%.
06	Zero Tracking Time	0.0	0.0 to 5.0	Zero tracking is performed in combination with CALF-07 Zero Tracking Width. It is not performed when set to 0.0. Its unit is seconds
07	Zero Tracking Width	0	0 to 9	Zero tracking is performed in combination with CALF-06 Zero Tracking Time. It is not performed when set to 0. Its least input increment is 1/2D. (The width for setting of 1 is equivalent to 1/2 of the minimum graduation)
	<p>The ZERO Tracking comp. function will automatically bring the display back to Zero when there are small deviations.</p> <p>The ZERO Tracking comp. function works only within the range as shown in the graph.</p>			

CALF-	Name	Setting				
		Default	Parameter	Description		
08	Motion Detection Time	1.0	0.0 to 5.0	Motion is detected in combination with CALF-09 Motion Detection Width. It is not detected when set to 0. Its unit is seconds.		
09	Motion Detection Range	2	0 to 9	Motion is detected in combination with CALF-08 Motion Detection Time. Its least input increment is 1D. (The range for setting of 1 is equivalent to the minimum division)		
	<p>Motion Detection is a function which sends a signal, "Motion", when the weighing data remains within a certain range.</p>					
10	Tare and Zero at Unstable Weight Value	1	0	"Tare" is not accepted when the weight value is unstable.	Not available on the USA version.	
			1	"Tare" is accepted even if the weight value is unstable.		
11	Tare at Negative gross	1	0	"Tare" is not accepted when the gross weight is negative.		
			1	"Tare" is accepted even if the gross weight is negative.		
12	Standard Serial Output; Output When Weight Value Is Overflowing or Unstable	1	0	Does not output when the weight value is overflowing or unstable		
			1		Outputs even if the weight is overflowing or unstable	
13	RS-232C/-422/-485; Output When Weight Value Is Overflowing or Unstable	1	0	Does not output when the weight value is overflowing or unstable.		
			1		Outputs even if the weight value is overflowing or unstable	
14	Weighing Mode	3	1	Normal batching (Customer programmed control mode)	Batch Weighing	For the hopper scale use
			2	Loss-in-weight (Customer programmed control mode)		
			3	Normal batching (Built-in automatic program mode)		
			4	Loss-in-weight (Built-in automatic program mode)		
			5	Check weighing 1	Check Weighing	For the platform scale use
			6	Check weighing 2		
			7	Check weighing 3		
			8	Check weighing 4		

15	Zero Input Voltage	0.000000	0.000000 to 2.200000	Input Voltage (mV/V) from the Load Cell at "Zero", which is determined in "Zero Calibration" with weights.
16	Span Input Voltage (Capacity to zero)	3.200000	0.000000 to 3.200000	Input Voltage (mV/V) from the Load Cell at "Span", which means the difference between Capacity and Zero. The voltage is determined in "Span Calibration" with weights.
17	Weight against Span Input Voltage	16000	0 to 800000 (decimal point ignored)	When "Digital-Calibration", calibration not using weights, is performed, CALF-15 and CALF-16 also have to be done. This setting will be changed to Capacity (CAL-04) if "CAL Set" is done.
				<p>Note: Write down the value of CALF-15, and CALF-17 on the setting list attached back of this manual for the maintenance purpose. (Accuracy at replacement: approximately 1/500)</p> <p>The scale can be calibrated with the stored value, CAL-15, CALF-17. (Digital span function approximately 1/1000) However it is recommended to use weights for a better accuracy.</p>

5-4 CALIBRATION ERRORS

Err messages	Causes	Solutions
CErr 0	The minimum graduation is other than 1, 2, 5, 10, 20, and 50.	Confirm setting of the minimum graduation, CALF-03.
CErr 1	Resolution (weighing capacity/minimum graduation) is more than 16000.	Confirm the relations between the weighing capacity, CALF-04, and minimum graduation, CALF-03.
CErr 2	The voltage of the zero calibration point is overloaded in the positive direction.	Confirm the rating and connection of the load cell and see if the load cell is damaged.
CErr 3	The voltage of the zero calibrated point is overloaded in the negative direction.	When the load cell is connected properly and is not defective, the load cell output can be corrected by attaching a resistor as shown below, "Load cell output compensation". When it is likely that the load cell or A/D converter is defective, use the check mode in 10-1 to verify the problem.
CErr 4	The calibration weight is more than the weighing capacity.	Calibrate with the proper calibration weights.
CErr 5	The calibration weight is less than the minimum graduation	
CErr 6	Sensitivity of the load cell is insufficient.	When "C Err 6" or "C Err8" is displayed after CALF-03 (Minimum division setting) and CALF-04 (Capacity setting) have been set, try to do the following settings for solution. <ul style="list-style-type: none"> • Reset CALF-03. • Reset CALF-04. • Set CALF-16 to "3.200000". • Set CALF-17 to the capacity weight.
CErr 8	The output voltage of the load cell is too high with the span capacity loaded,	
CErr 7	The voltage of the span calibration point is negative with respect to the zero point.	Confirm the connection of the load cell.

LOAD CELL OUTPUT COMPENSATION

Attach a resistor to a place as shown in the picture below to compensate the load cell output.

- **Use a resistor with as high resistance and low temperature coefficient as possible.**

"C Err 2" (Overloaded in the positive direction)

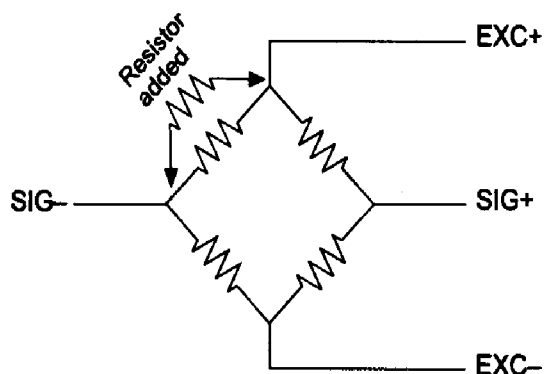

"C Err 3" (Overloaded in the negative direction)

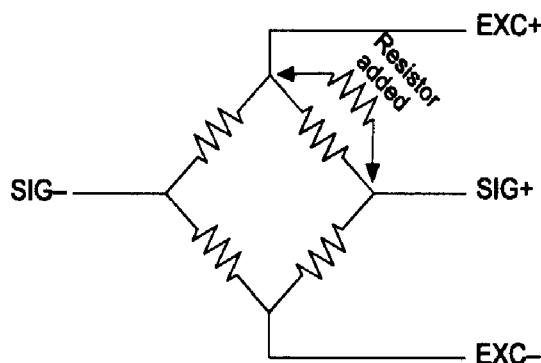

5-5 INITIALIZATION OF ALL THE DATA

This is to initialize all the data of the EEPROM and RAM. Therefore, the calibration data and general function data are also initialized. For the details, see 10-2.

CHAPTER 6 GENERAL FUNCTIONS

The general functions determine the operations of the AD-4401 and are all stored in the EEPROM. Each function is sorted into the groups by capabilities and represented by prefixing a function number (F-XX) with its group name. This chapter describes how to set the general functions and their details. For functions related to options, see the descriptive sections for the options.

SETTING METHOD

Step 1 With the [ENTER] key pressed and held, press the [SETPOINT] key. "Fnc" is displayed to inform you that the indicator is entering the general function mode.

- **Note: When you did not want to enter the function mode, press the [ESC] key. The indicator will return to the normal mode.**

Step 2 Press the [ENTER] key. The indicator will switch to the general function mode and the cursor appears at the letter, "c".

Step 3 Select the target function group, using the [^], and [v] keys

After selecting the function group, press the [ENTER] key. (In this example, select Basic Capabilities Related)

The main display section displays the function number and the cursor appears in the lowest digit. The Subdisplay section displays a set value for the function.

Group Name	Symbol
Basic Capabilities Related	Fnc
Weighing Sequence Related	Sq
Control I/O Input Related	in
Control I/O Output Related	out
Standard Serial Output Related	si
Parallel BCD Output Related	bcd
RS I/O Related	rS
Setpoint Value input Related	SP
Analog Output Related	An

Step 4 Using the [<], [>], [^], and [v] keys, select the function number you want to set. In this example, select FNCF-02. For your information, FNCF-02 is a capability of the [F] key.

Step 5 In this example, set the [F] key to a "print command." Press the [ENTER] key. The Subdisplay section starts blinking.

Step 6 Press the [^] key. The Subdisplay section displays "1".

Step 7 Press the [ENTER] key. The main display section starts blinking and you are returned to Step 4, selection of the function number.

Step 8 Press the [ESC] key. The function number disappears and you are returned to Step 2.

Step 9 Press the [ESC] key again. The settings so far are saved in the EEPROM and the indicator is returned to the normal mode.

6-1 BASIC CAPABILITIES RELATED

FNCF-	Name	Setting		Description	
		Default	Parameter		
01	Key switch disable	00000000	00000000 to 11111111		<p>Each bit corresponding to the relevant key. This function is only available in the normal mode. All keys are usable if keys are enabled in the Control I/O (see6-3),</p>
				<table border="1"> <tr> <td>0</td> <td>Not disable</td> </tr> <tr> <td>1</td> <td>Disables</td> </tr> </table>	
0	Not disable				
1	Disables				
02	Capabilities of [F] Key	0	0	None	<p>* Denotes exclusive for Built-in automatic program mode.</p>
			1	Print command for manual print	
			2	Hold <i>Hold function by the [F] key is not available if there is any set to "HOLD" in the Control I/O (see6-3).</i>	
			3	*Batch Start	
			4	*Emergency stop	
			5	Clear to zero	
			6	Clear tare	
			7	Clear accumulation	
03	Display Rewrite Rate	1	1	20 times/sec	
			2	10 times/sec	
			3	5 times/sec	
04	Display Content of Subdisplay Section	0	0	None	<p>Paste the accessory label to the front panel in compliance with the display content.</p>
			1	Gross	
			2	Net	
			3	Tare	
			4	Final value (target weight)	
			5	Accumulated weight	
6	Accumulated count				

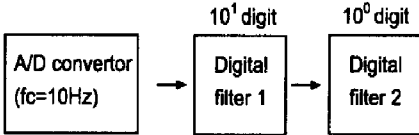
FNCF-	Name	Setting			
		Default	Parameter	Description	
05	" <input type="checkbox"/> " Status display Capability	0	0	None	"Discharging" is exclusively intended for normal batching (built-in automatic program mode).
			1	* discharging	
			2	Zero tracking	
06	Digital Filter (Series connection of two digital filters.)	48	00 to 79	Value of each digit and cutoff frequency	<p>The digital filter is designed to suppress dispersion of a load cell output signal. Two of them are connected in series as shown below.</p>  <pre> graph LR ADC[A/D converter (fc=10Hz)] --> DF1[Digital filter 1 (10¹ digit)] DF1 --> DF2[Digital filter 2 (10⁰ digit)] </pre> <p>Low frequency components, which cannot be covered only by setting of the digital filters, can be dealt with by equivalently lowering the cutoff frequency of the digital filters at FNCF-07.</p>
				0: None	
				1: 11.0Hz	
				2: 8.0Hz	
				3: 5.6Hz	
				4: 4.0Hz	
				5: 2.8Hz	
				6: 2.0Hz	
				7: 1.4Hz	
				8: 1.0Hz	
9: 0.7Hz					
07	Sampling frequency dividing ratio.	1	1 to 10	Lower the cutoff frequency of the digital filters equivalently by reducing the specified sampling times to one.	
08	Hold operation	1	1	Normal hold	During peak hold, the positive peak of the weight value is held.
			2	Peak hold	
09	Comparison stop at "hold"	0	0	No	In Built-in automatic program mode, do not set "1" because the weighing sequence stops when comparison stops.
			1	Yes	

6-2 WEIGHING SEQUENCE RELATED

SQF-	Name	Default	Setting		
			Parameter	Description	
01	Selection of comparison weight	1	1	Internal count	See 7-6 for details.
			2	Display count	
02	Automatic accumulation	0	0	No Automatic accumulation	See 7-8 for details.
			1	Accumulates only acceptable weight	
			2	Accumulates all values	
03	Automatic free fall compensation	0	0	No automatic free fall compensation	Only effective in Batch weighing mode
			1	Moving average of last four times (See 7-9 for details.)	
			2	Fuzzy automatic free fall compensation (See 7-10 for details.)	Only effective in Built-In-Automatic Program mode.
04	Automatic free fall effective width.	0	0 to 99999999	Automatic free fall compensation is made if a loaded weight is within the final +/- automatic free fall effective width.	Only effective in Batch weighing mode.
05	Unstable Dribble Flow Timer	3.0	0.0 to 25.5 (In step of 0.1 second)	If Dribble Flow-time is shorter than the setting, the preset Free Fall is applied to the weighing instead of the Auto-Free-Fall compensation.	Only effective in Built-In-Automatic Program mode.
06	Overlimit/underlimit operation	2	1	Real-time comparison	
			2	Synchronized with Batch Finish Output	
07	Stability at judgment	1	0	Not required	
			1	Required	
08	Maximum number of supplementary flow times	0	0 to 255	0: Unused	
				Non-0: Set times	

SQF-	Name	Default	Setting						
			Parameter	Description					
09	Batch start wait timer	0.0	0.0 to 25.5 (In step of 0.1 second)	Intentionally blank	Only effective in Built-In-Automatic Program mode.				
10	Full-flow comparator Inhibiter timer	0.0			Only normal batching(built-in automatic program mode) is effective				
11	Medium-flow comparator Inhibiter timer	0.0			0: Until next Batch start	Only effective in Built-In-Automatic Program mode.			
12	Dribble-flow comparator Inhibiter timer	0.0							
13	Judgment wait timer	0.1			Non-0: Set time				
14	Batch Finish complete output width	0.0			0: Unused				
15	Batch monitoring timer	0			Non-0: Set time				
16	Supplementary flow open timer	0.10			0.01 to 2.55 (In step of 0.01 second)		(Intentionally blank)		
17	Supplementary flow close timer	0.1							
18	Discharging start wait timer	0.0			0.0 to 25.5 (In step of 0.1 second)			Only normal batching(built-in automatic program mode) is effective	
19	Discharging valve close wait timer	0.1							
20	Discharging time monitor timer	0			0: Unused				
21	Add the final to zero band setting	0			0				Does not add the final
					1				Adds the final
22	Add the final to full setting	0	0	Does not add the final					
			1	Adds the final					

6-3 CONTROL I/O INPUT RELATED

INF-01 through INF-06 represents the input terminals A1 through A6, respectively. The content of setting is common to each terminal. but initial setting differs.

INF-01: Capability of Input Terminal A1					
INF-02: Capability of Input Terminal A2					
INF-03: Capability of Input Terminal A3					
INF-04: Capability of Input Terminal A4					
INF-05: Capability of Input Terminal A5					
INF-06: Capability of Input Terminal A6					
Default					
Setting					
Parameter					
Description					
0					
No capability					
1					
Zero					
2					
Tare					
3					
Batch start					
4					
Emergency stop					
5					
Discharge start					
6					
Key enable					
7					
Automatic free fall command					
8					
Disable thumbwheel switch read					
9					
Clear tare					
10					
Accumulation command					
11					
Cancel previous accumulation					
12					
Clear accumulation					
13					
Hold					
14					
Print command for manual print					

6-4 CONTROL I/O OUTPUT RELATED

OUTF-01 through OUTF-08 represent the output terminals B1 through B8, respectively. The content of setting is common to each terminal. but initial setting differs.

OUTF-01: Capability of Output Terminal B1							
OUTF-02: Capability of Output Terminal B2							
OUTF-03: Capability of Output Terminal B3							
OUTF-04: Capability of Output Terminal B4							
OUTF-05: Capability of Output Terminal B5							
OUTF-06: Capability of Output Terminal B6							
OUTF-07: Capability of Output Terminal B7							
OUTF-08: Capability of Output Terminal B8							
Default							
Setting							
Parameter							
Description							
0							
No capability							
1							
Zero range							
2							
Underlimit / (Hi-Hi)							
3							
Overlimit / (Hi)							
4							
Full flow / [Full] / (Go)							
5							
Medium flow / (Lo)							
6							
Dribble flow / (Lo-Lo)							
7							
Discharge gate open							
8							
Batch Finish							
9							
Stability							
10							
Online							
11							
Weighing sequence running							
12							
Weighing sequence error							
13							
Input acknowledge							
14							
Zero range error							
15							
Weighing capacity overflow							
16							
Low battery							

6-5 STANDARD SERIAL OUTPUT RELATED

SIF-	Name	Setting			
		Default	Parameter	Description	
01	Output Data	1	1	Displayed weight	A & D standard format
			2	Gross	
			3	Net	
			4	Tare	
			5	Gross/Net/Tare	Accumulation data format
			6	Accumulated weight	
			7	Accumulated counts	
			8	Accumulated weight /Accumulated counts	
02	Data transmitting mode	1	1	Stream mode	
			2	Auto-Print mode	
			3	Manual-Print mode	
03	Baud rate	2	1	600 bps	
			2	2400 bps	

CHAPTER 7 WEIGHING SEQUENCE

7-1 WEIGHING SEQUENCE

GENERAL DESCRIPTION

Weighing sequence, means to output control signals to the units connected to the Control I/O, etc., by means of input signals from the load cell and external unit. In order to cope with a wide range of applications, the AD-4401 has various weighing sequences.

The weighing sequence differs depending on the weighing mode. The AD-4401 has 8 kinds of weighing modes; four kinds of "batch weighing" for the hopper scale and other 4 kinds of "check weighing" for the platform scale.

The weighing modes can be sorted into "customer programmed control mode" and "built-in-automatic program mode", depending on their operations. The following describes their difference.

Customer programmed control mode

Always compares a weight to a setpoint and outputs its result to the Control I/O.

Built-in-automatic program mode

So that a hopper scale gate can be controlled by the AD-4401 alone, the control software conventionally contained in the PLC is now incorporated in the weighing sequence.

Loading is initiated by a batch start signal from an external unit, and when the specified weight is obtained, a gate is closed and a loading result is judged.

The AD-4401 can also deal with a discharging sequence.

Weighing Mode CALF-14			Operation	Application
1	Normal batching (Customer programmed control mode)	Batch Weighing Mode	Customer Programmed Control mode (Real-time)	Hopper scale
2	Loss-in-weight (Customer programmed control mode)			
3	Normal batching (Built-in automatic program mode)		Built-in automatic program mode	
4	Loss-in-weight (Built-in automatic program mode)			
5	Check weighing 1	Check Weighing Mode	Customer Programmed Control mode (Real-time)	Platform scale
6	Check weighing 2			
7	Check weighing 3			
8	Check weighing 4			

A sequence signal (comparison result) is output to the Control I/O. For the details of the Control I/O, see 8-1.

FUNCTIONING OF EACH WEIGHING MODE

The setpoints used in the weighing sequence are set with the keys, thumbwheel switches, and so on. The keys and 5-digit mode thumbwheel switch may be used in the same manner regardless of the weighing mode. When using the 16-digit mode thumbwheel switch, however, its digit distribution varies from one weighing mode to another. The following describes the functioning of each weighing mode and connection of the 16-digit mode thumbwheel switch.

7-2 CUSTOMER PROGRAMMED CONTROL MODE

NORMAL BATCHING (WEIGHING MODE: CALF-14 = 1)

Output Terminal	Output Condition
Zero band	Gross \leq Zero band
Full Flow	Net \geq Final - Optional preliminary
Medium Flow	Net \geq Final - Preliminary
Dribble Flow	Net \geq Final - Free fall
Overlimit	Net $>$ Final + Overlimit
Underlimit	Net $<$ Final - Underlimit

When an output condition is established, a relevant output terminal is turned on (power continuity with output COM).

An output terminal number can be selected with the general functions, OUTF-01 through OUTF-08. A setpoint signal output is turned off unconditionally when the operation mode is other than the normal mode.

For the connection of the thumbwheel switch (16-digit mode) for the setpoints, see 7-4.

FUNCTIONAL DESCRIPTION

1. First, press TARE to clear the display on the AD-4401 to zero.
2. Open gates G1 (full flow), G2 (medium flow), and G3 (dribble flow). The display on the AD-4401 is incremented, and when it reaches optional preliminary its output is turned on and closes gate G1.
3. When the display reaches preliminary its output is turned on and closes gate G2.
4. When the display reaches final its output is turned on and closes gate G3. Now, one weighing cycle is completed and the AD-4401 display shows the final value, indicating that hopper 2 has been loaded with that weight. Use the overlimit/underlimit setting to check whether the weighing value is within limits.
5. When you open gate G4 to discharge into a container, you can use the setting of the zero range to make sure that the raw material has been completely discharged. However, the AD-4401 cannot control the discharge gate G4.

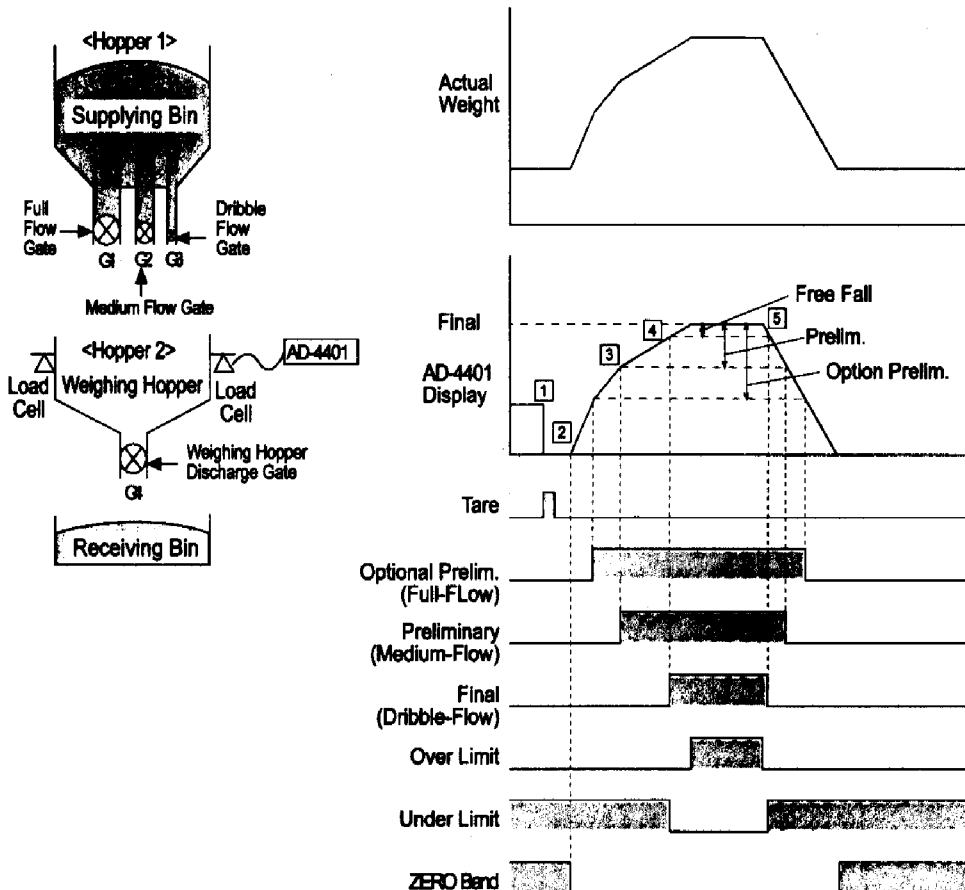

LOSS-IN-WEIGHT (WEIGHING MODE CALF-14 = 2)

Output Terminal	Output Condition
Zero band	Gross \leq Zero band
Full (Hopper Full)	Gross \geq Full
Medium Flow	-Net \geq Final - Preliminary
Dribble Flow	-Net \geq Final - Free fall
Overlimit	-Net $>$ Final + Overlimit
Underlimit	-Net $<$ Final - Underlimit

When an output condition is established, a relevant output terminal is turned on (power continuity with output COM).

An output terminal number can be selected with the general functions, OUTF-01 through OUTF-08.

A setpoint signal output is turned off unconditionally when the operation mode is other than the normal mode.

For the connection of the thumbwheel switch (16-dit mode) for the setpoints. see 7-4.

FUNCTIONAL DESCRIPTION

- Initially, with the weighing hopper 2 being empty, the AD-4401 displays the zero range at the gross.
 - In this state, open gate G1. When the display on the AD-4401 reaches the Full (optional preliminary) set value, its output is turned on and closes gate G1. The weighing hopper 2 has now been filled with raw material.
 - Press TARE. The display on the AD-4401 is cleared to 0.
 - Open gates G2 and G3. The display of the AD-4401 is decremented, and when it reaches preliminary its output is turned on and closes gate G2.
 - When the display reaches final output is turned on and closes gate G3.
- Now, one weighing cycle has completed and the display on the AD-4401 shows the final value, indicating that receiving bin has been loaded with that weight. Use the setting of overlimit/underlimit to check whether the weighing value is within limits.
- When the volume of material left in the weighing Hopper 2 becomes less than Zero band, Zero band Output signal is turned on.

Note: SQF-21/ SQF-22 setting enables to add automatically **FINAL** to **ZERO BAND** or **FULL**. Therefore there is always enough ingredient left in the hopper for a measurement.

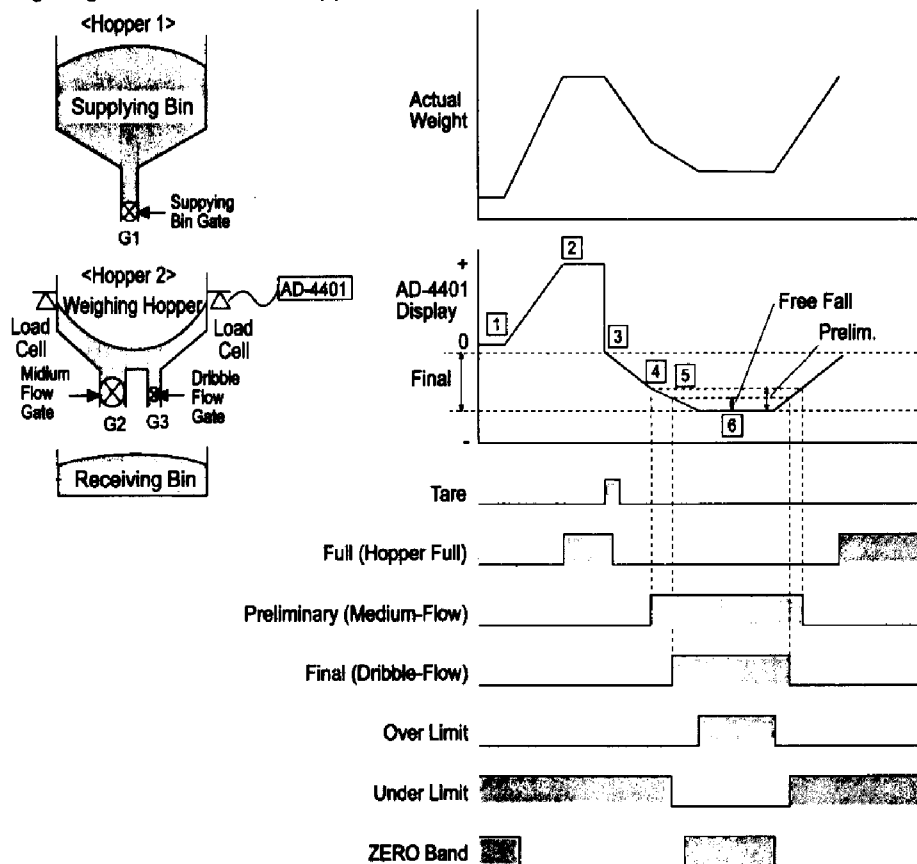

7-3 BUILT-IN AUTOMATIC PROGRAM MODE

NORMAL BATCHING / NO SUPPLEMENTARY FLOW (WEIGHING MODE CALF-14 = 3)

Output Terminal	Output Condition
Zero band	Gross \leq Zero band
Full Flow	Net \geq Final - Optional preliminary
Medium flow	Net \geq Final - Preliminary
Dribble flow	Net \geq Final - Free Fall
Overlimit	Net $>$ Final + Overlimit
Underlimit	Net $<$ Final - Underlimit

When an output condition is established, full flow, medium flow, and dribble flow outputs are turned off, but the other outputs are turned on.

Once the full flow, medium flow, and dribble flow are turned off, they are not turned on until the next start of loading.

Overlimit/underlimit is activated based on the net upon batch finish. (May be changed to real-time operation)

The zero range is a customer programmed control mode operation.

For the connection of the thumbwheel switch (16-digit mode) for setpoints, see 7-4.

FUNCTIONAL DESCRIPTION

1. The instrument is waiting for a batch start signal or discharging start signal to be input.
2. When the batch start signal is input, the Batch Start wait timer starts.
3. When the Batch Start wait timer completes the set time;
 - Full-flow, medium-flow, and dribble-flow output signals are turned on.
 - The full-flow comparator inhibitor timer starts.
 - The Batch monitoring timer starts.
4. When the weight reaches optional preliminary setting:
 - The full-flow output is turned off.
 - The medium-flow comparator inhibitor timer starts.
5. When the weight reaches preliminary' setting:
 - The medium-flow output is turned off.
 - The dribble-flow comparator inhibitor timer starts.
6. When the weight reaches free fall setting:
 - The dribble-flow output is turned off.
 - The judgment wait timer starts.
7. When the weight has stabilized after the judgment wait timer completes the set time;
 - If automatic free fall compensation is being used, its calculation will be made.
 - The Batch Finish output signal is turned on.
 - If there is excess or shortage, a judgment result output signal (overlimit or underlimit) will be turned on.
 - The Batch monitoring timer is reset.
 - The net is accumulated automatically.
 - The data is output from the interface set for auto print.
8. If the discharging start signal is input, the discharging start wait timer will start.
9. When the discharging start wait timer completes the set time;
 - The discharging output signal is turned on.
 - The discharging time monitor timer starts.
10. When the gross becomes lower than the zero range;
 - The discharging valve close wait timer starts.
 - The discharging time monitor timer is reset.

11. When the discharging valve close wait timer completes the set time, the discharging output signal is turned off.
12. When the Batch Start input signal for the next cycle is input;
 - The Batch Finish output signal is turned off.
 - The judgment result output signal (overlimit or underlimit) is turned off.
 - Now, the weighing sequence has cycled and restarts from Step 2 at this time.

Note: In the case of built-in-automatic program mode batching, the setpoint data is held until batch finish since start of batching. Therefore, a setpoint altered during loading takes effect after batch finish is output.

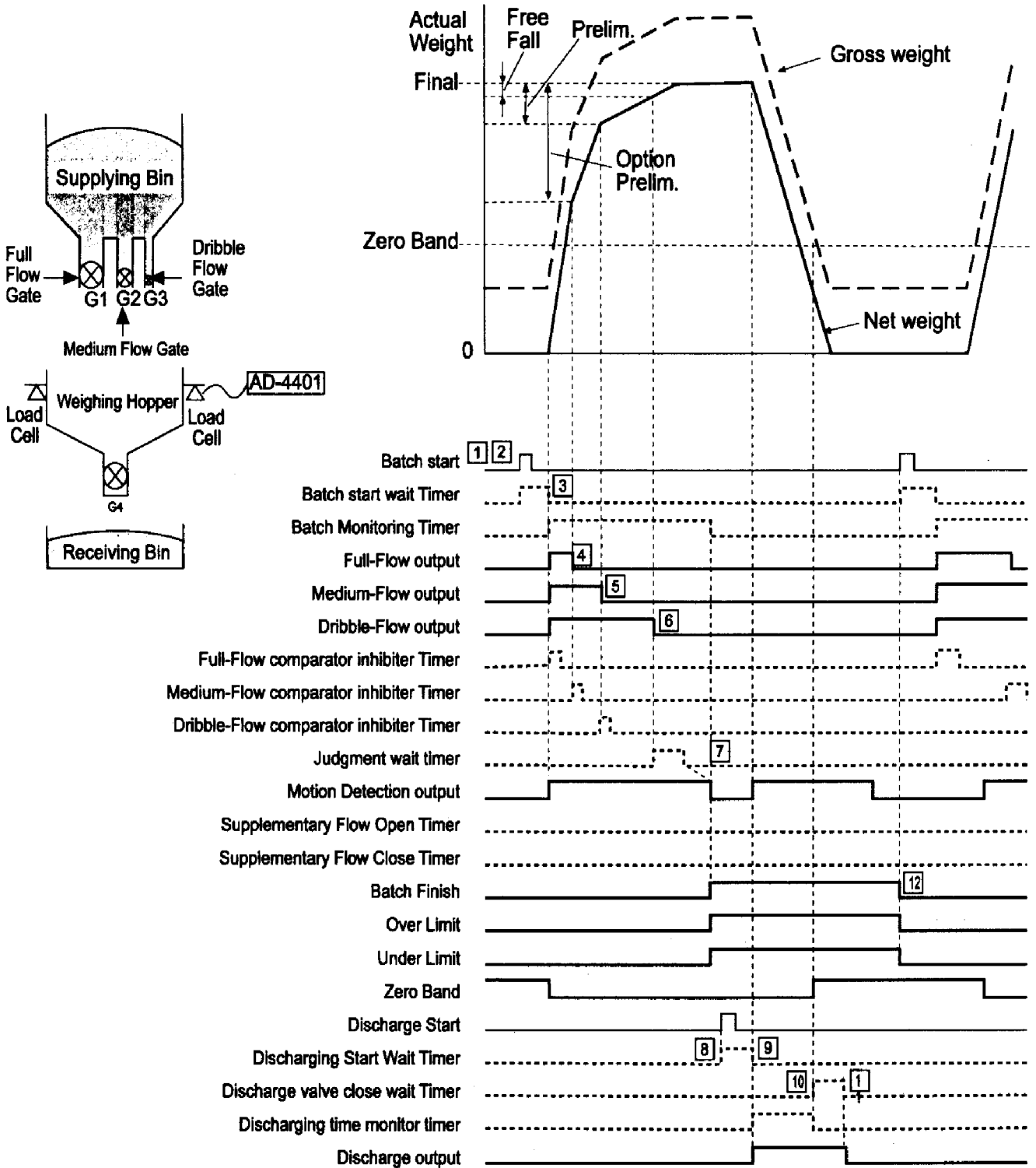

NORMAL BATCHING/ WITH SUPPLEMENTARY FLOW (WEIGHING MODE CALF-14 = 3)

Supplementary flow automatically turns on the dribble flow for the specified time when the loaded weight is not sufficient. To make supplementary flow, set the "maximum supplementary flow times, SQF-07," to other than 0, and the "supplementary flow open timer, SQF-15," and "supplementary flow close timer, SQF-16," to their respective times. Supplementary flow is also available in loss-in-weight (built-in automatic program mode).

FUNCTIONAL DESCRIPTION

1. The instrument is waiting for the Batch Start signal or discharging start signal to be input.
2. When the external Batch Start signal is input, the Batch Start wait timer starts.
3. When the Batch Start wait timer completes the set time;
 - Full-flow, medium-flow, and dribble-flow output signals are turned on.
 - The full-flow setpoint disable, and the Batch monitoring timers start.
4. When the weight reaches optional preliminary setting:
 - The full-flow output is turned off.
 - The medium-flow comparator inhibitor timer starts.
5. When the weight reaches preliminary setting:
 - The medium-flow output is turned off.
 - The dribble-flow comparator inhibitor timer starts.
6. When the weight reaches free fall setting:
 - The dribble-flow output is turned off.
 - The judgment wait timer starts.
 - The Batch monitoring timer is reset.
7. When the weight has stabilized after the judgment wait timer completes the set time;
 - If automatic free fall compensation is being used, its calculation will be made.
 - If the net is insufficient;
 - The dribble-flow output signal is turned on.
 - The supplementary flow open timer starts.
8. When the supplementary flow open timer completes the set time;
 - The dribble-flow output signal is turned off.
 - The supplementary flow close timer starts.
9. When the supplementary flow close timer completes the set time;
 - It is checked whether the net is insufficient, and if yes;
 - The dribble-flow output signal is turned on.
 - The supplementary flow open timer starts.
10. When the supplementary flow open timer completes the set time;
 - The dribble-flow output signal is turned off.
 - The supplementary flow close timer starts.
11. When the supplementary flow close timer completes the set time;
 - It is checked whether the net is insufficient, and if not;
 - The Batch Finish output signal is turned on.
 - If a judgment result is overlimit, an overlimit output is turned on.
 - The Batch monitoring timer is reset.
 - The net is accumulated automatically.
 - The data is output from the interface set for auto print.
12. If the discharging start input signal is turned on, the discharging start wait timer will start.

13. When the discharging start wait timer completes the set time;
 - The discharging output signal is turned on, and the discharging time monitor timer starts.
14. When the gross becomes lower than the zero range;
 - The discharging valve close wait timer starts.
 - The discharging time monitor timer is reset.
15. When the discharging valve close wait timer completes the set time, the discharging output signal is turned off.
16. When the Batch Start signal for the next cycle is input;
 - The Batch Finish output signal is turned off.
 - The judgment result output signal (overlimit or underlimit) is turned off.
 - Now, the weighing sequence has cycled and restarts from Step 2 at the same time.

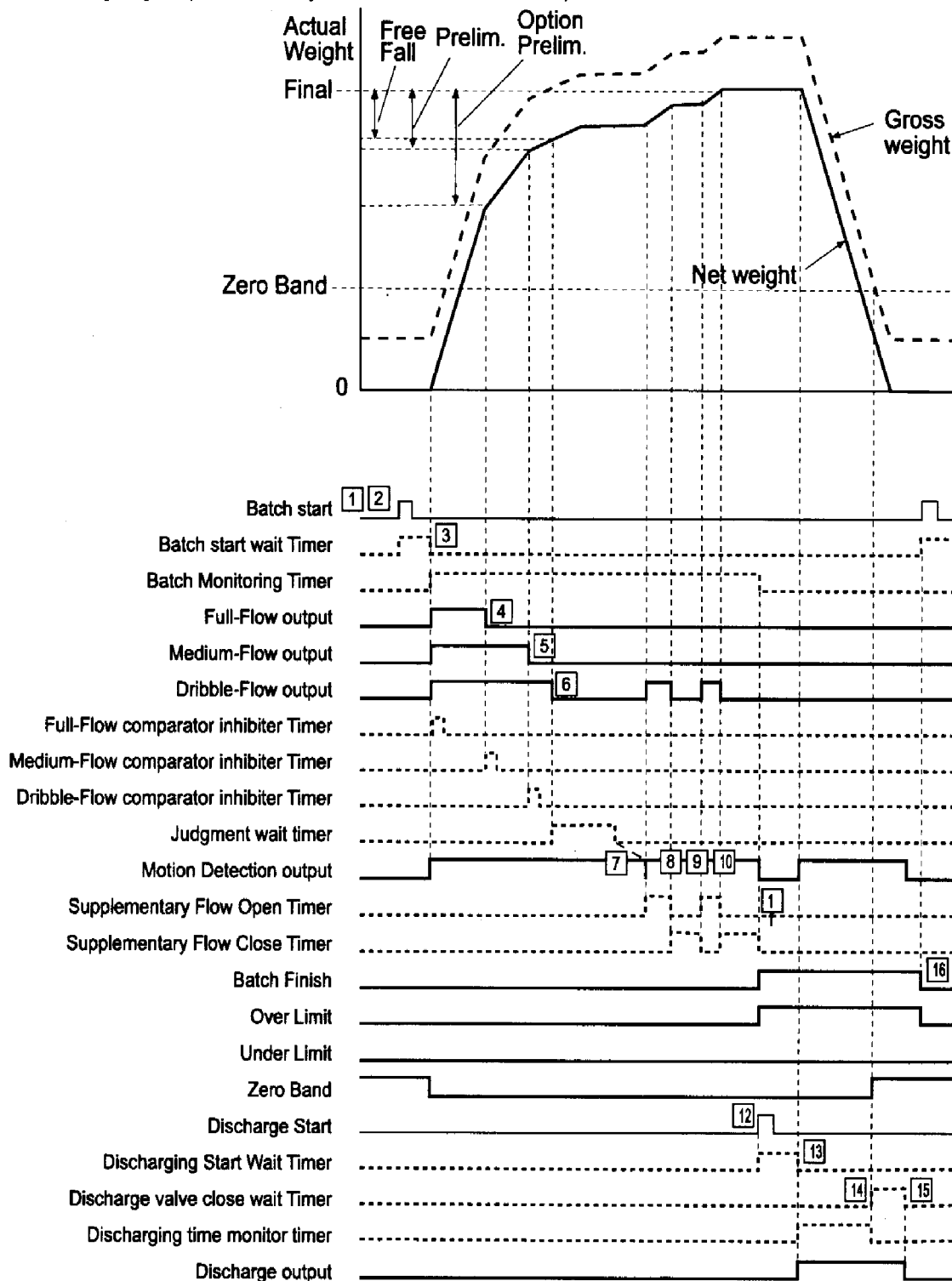

LOSS-IN-WEIGHT (WEIGHING MODE CALF-14 = 4)

Output Terminal	Output Condition
Zero band	Gross \leq Zero band
Full (Hopper full)	Gross \geq Final - Full
Medium flow	- Net \geq Final - Preliminary
Dribble flow	- Net \geq Final - Free Fall
Overlimit	- Net $>$ Final + Overlimit
Underlimit	- Net $<$ Final - Underlimit

When an output condition is established, medium flow and dribble flow outputs are turned off, but the other outputs are turned on.

Once the medium flow and dribble flow are turned off, they are not turned on again until the next start of loading.

The overlimit/underlimit is activated based on the net upon batch finish. (Can be changed to Real-time mode operation)

The zero range is a customer programmed control mode operation.

For the connection of a thumbwheel switch (16-digit mode) for setpoints, see 7-4.

FUNCTIONAL DESCRIPTION

1. If the zero range signal is being output, replenish the raw material until a full signal is output.
2. Wait for stabilization and input a tare subtraction signal.
3. If a Batch Start signal is input, the Batch Start wait timer starts.
4. When the Batch Start wait timer completes the set time;
 - The medium and dribble-flow output signals are turned on.
 - The medium-flow comparator inhibitor timer starts.
 - The Batch monitoring timer starts.
5. When the weight reaches preliminary setting:
 - The medium-flow output is turned off.
 - The dribble-flow comparator inhibitor timer starts.
6. When the weight reaches preliminary free fall setting:
 - The dribble-flow output is turned off.
 - The judgment wait timer starts.
7. When the weight has stabilized after the judgment wait timer completes the set time;
 - If automatic free fall compensation is being used, its calculation will be made.
 - The Batch Finish output signal is turned on.
 - If there is an excess or shortage, the judgment result output signal (overlimit or underlimit) is turned on.
 - The Batch monitoring timer is reset.
 - The net is accumulated automatically.
 - The data is output from the interface set for auto print.

Note:

SQF-21 and SQF-22 settings enable to add automatically **FINAL** to **ZERO BAND** or **FULL**. Therefore there is always enough ingredient left in the hopper for a measurement.

- In the case of built-in-automatic program mode batching, the setpoint data is held until batch finish since start of loading. Therefore, a setpoint altered during loading takes effect after batch finish is output.

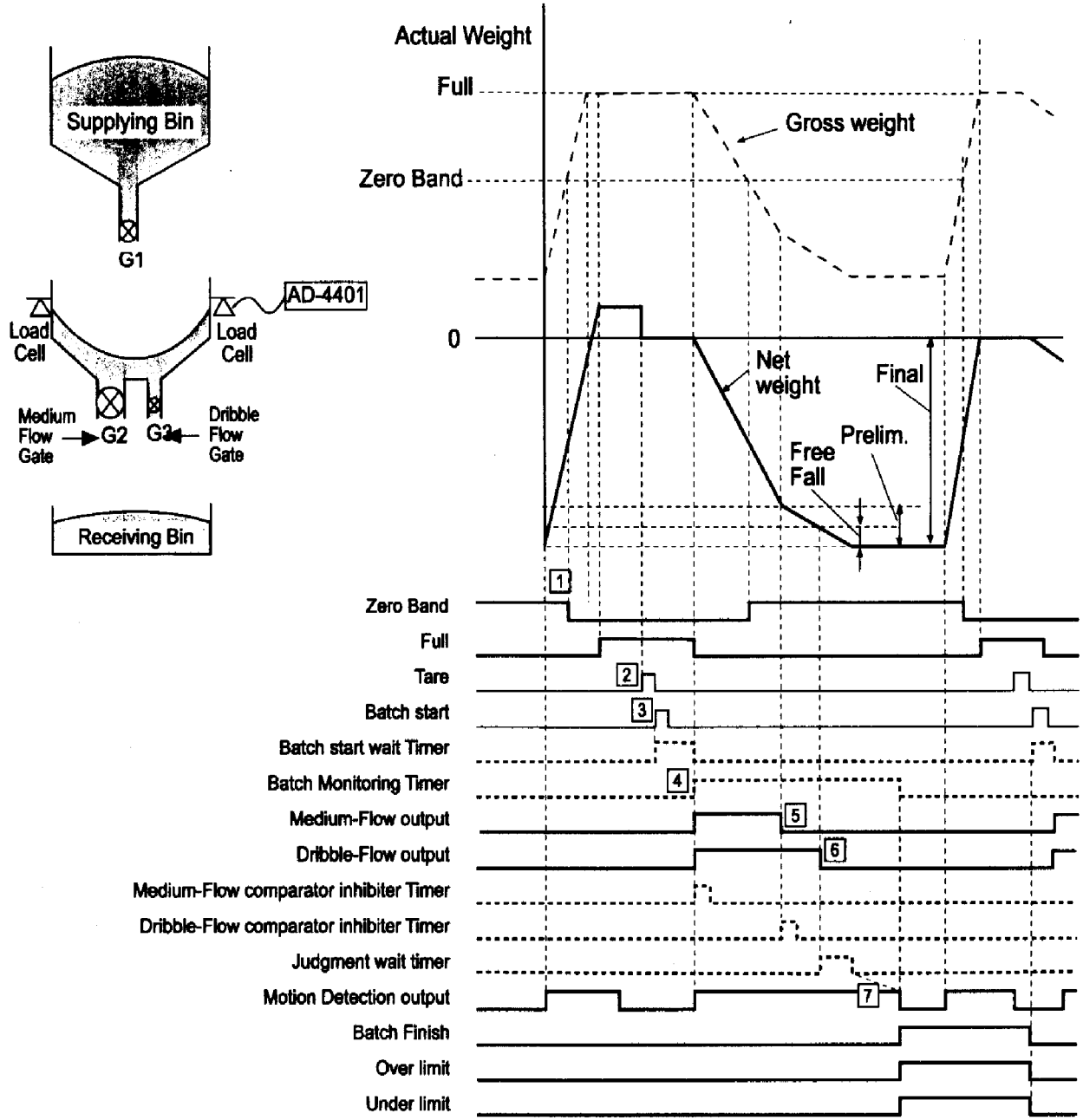

SUPPLEMENTARY DESCRIPTION FOR BUILT-IN-AUTOMATIC PROGRAM MODE

To subtract the tare automatically prior to loading

Set the Batch Start wait timer to 0.1 second or more and connect the tare subtraction input and the Batch Start input in parallel.

When using with a high-speed packer and it is difficult to stabilize after the judgment wait timer completes the set time

Set stability at Judgment to "Unrequired."

When the Batch Start signal is input while outputting the weighing completion signal

The Batch Start input is accepted and the weighing completion output is turned off.

To discharge prior to starting loading

Input the discharging start signal before the Batch Start signal. Begin with the discharging sequence.

When an emergency stop signal is input

Since the instrument waits for the Batch Start signal to be input, regardless of the running condition, all the loading signals and discharging signals are turned off. Also, a weighing sequence error signal is output. This signal is output continuously until the loading or discharging start signal is input.

When loading has taken more than the specified time, an alarm signal is output as follows

With the Batch monitoring timer, set the maximum expected loading time. If loading exceeds this time, each loading signal will be turned off and a weighing sequence error signal will be output. Input the Batch Start signal to reload, and input the discharging start signal to discharge.

Functioning of the comparator inhibitor timer

In order to prevent the medium-flow or dribble-flow gate from being closed by mistake due to fluctuations of the weight value resulting from vibration upon closing the full-flow gate, the weight value is not compared for the set time of the comparator inhibitor timer when the loading signal is changed.

Functioning of the medium flow when preliminary is set to 0

No medium flow is provided when preliminary is set to 0. Likewise, no full flow is provided when optional preliminary is set to 0. When free fall is set to 0, however, dribble flow is provided until the net exceeds the final.

Functioning of the medium flow and dribble flow when preliminary is set smaller than free fall

When the dribble flow is turned off, the medium flow is also forced to OFF.

Set Optional preliminary > Preliminary > Free Fall. (0 is allowed because of A8)

7-4 SUPPLEMENTARY DESCRIPTION FOR BATCH WEIGHING

When setting the setpoint with the 16-digit thumbwheel switch

In batch batching, connection of the 16-digit thumbwheel switch is common.

When SPF-01 = 2 is set, connect the thumbwheel switch to the SET POINT connector as show in the figure below.

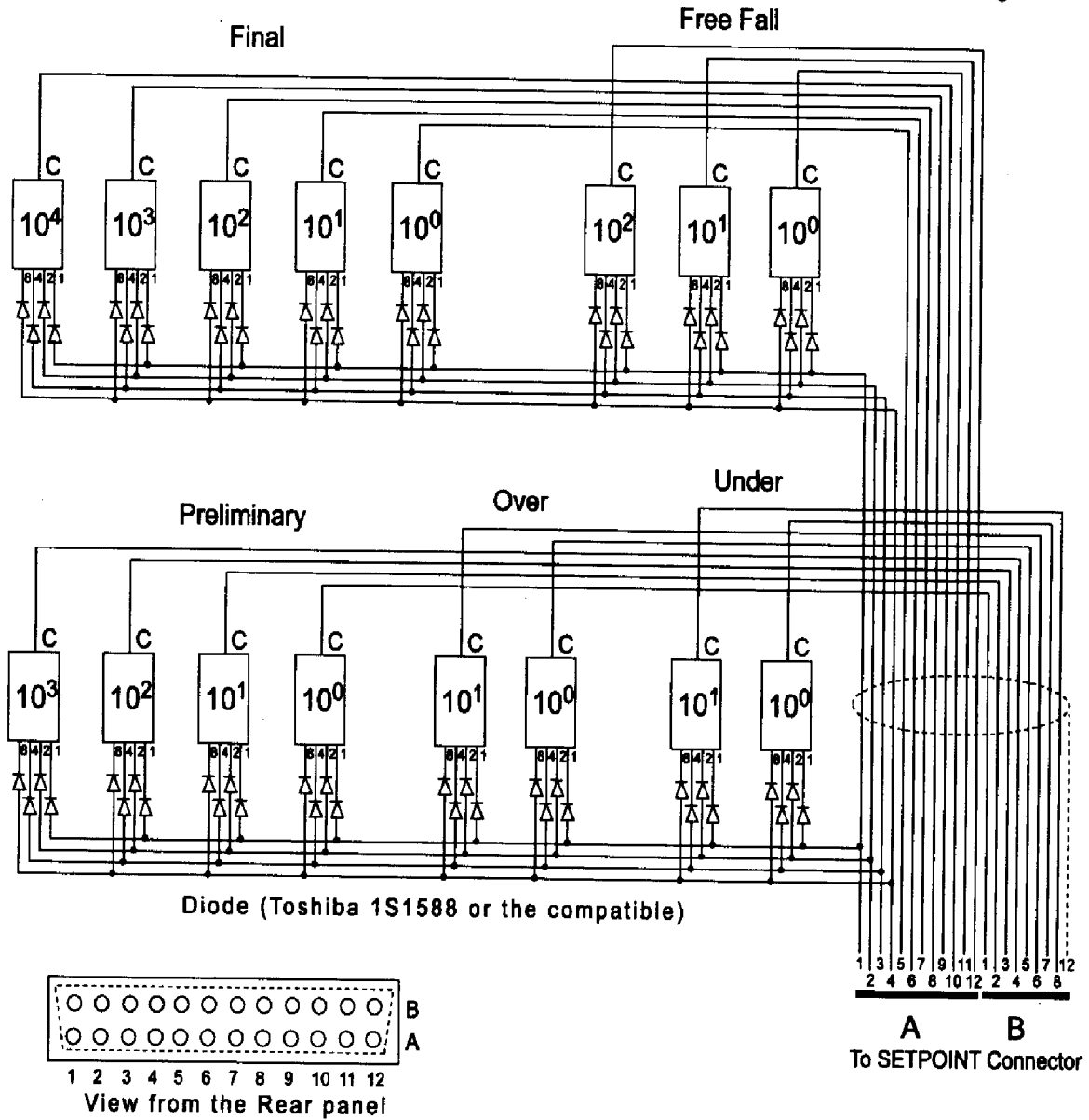

SETPOINT CONNECTOR WIRING

Pin #		Pin #	
A1	1	B1	Prelim. 10 ⁰
A2	2	B2	Prelim. 10 ¹
A3	4	B3	Prelim. 10 ²
A4	8	B4	Prelim. 10 ³
A5	Final 10 ⁰	B5	OVER 10 ⁰
A6	Final 10 ¹	B6	OVER 10 ¹
A7	Final 10 ²	B7	UNDER 10 ⁰
A8	Final 10 ³	B8	UNDER 10 ¹
A9	Final 10 ⁴	B9	
A10	Free Fall 10 ⁰	B10	
A11	Free Fall 10 ¹	B11	Used internally
A12	Free Fall 10 ²	B12	Shield

7-5 CHECK WEIGHING MODE

CHECK WEIGHING MODE 1 (WEIGHING MODE CALF-14 = 5)

Output Terminal	Output Condition
Zero band	Gross \leq Zero band
Hi-Hi	Net > Hi-Hi limit
Hi	Net > Target Weight + Hi limit
Go	Target Weight + Hi limit \geq Net \geq Target Weight - Lo limit
Lo	Net < Target Weight - Lo limit
Lo-Lo	Net < Lo-Lo limit

When an output condition is established, a relevant output terminal is turned on (power continuity with output COM). An output terminal number can be selected with the general functions, OUTF-01 through OUTF-08. The setpoint signal output is turned off unconditionally when the operation mode is other than the normal mode.

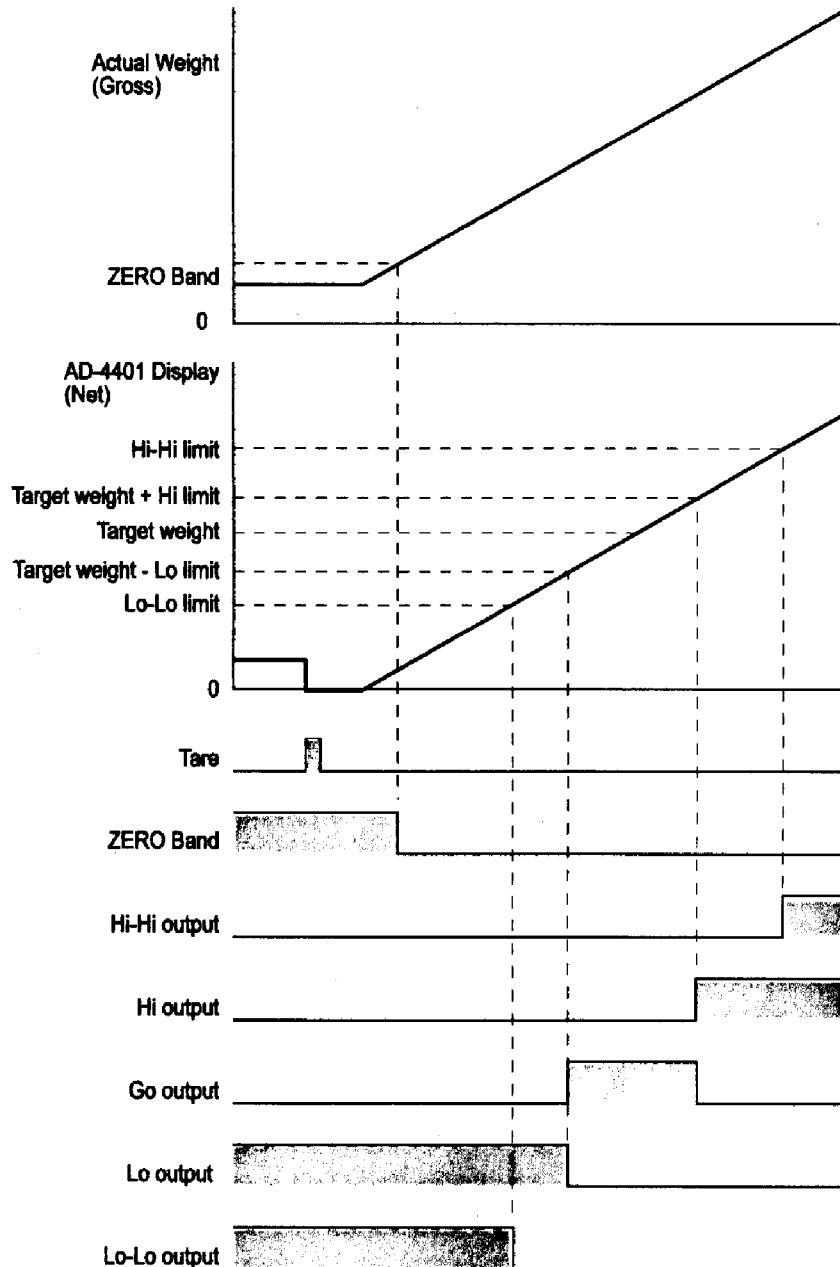

WHEN SETTING THE SETPOINT WITH A 15-DIGIT THUMBWHEEL SWITCH

When SPF-01 = 2 is set, connect the thumbwheel switch to the SET POINT connector as show in the figure below.

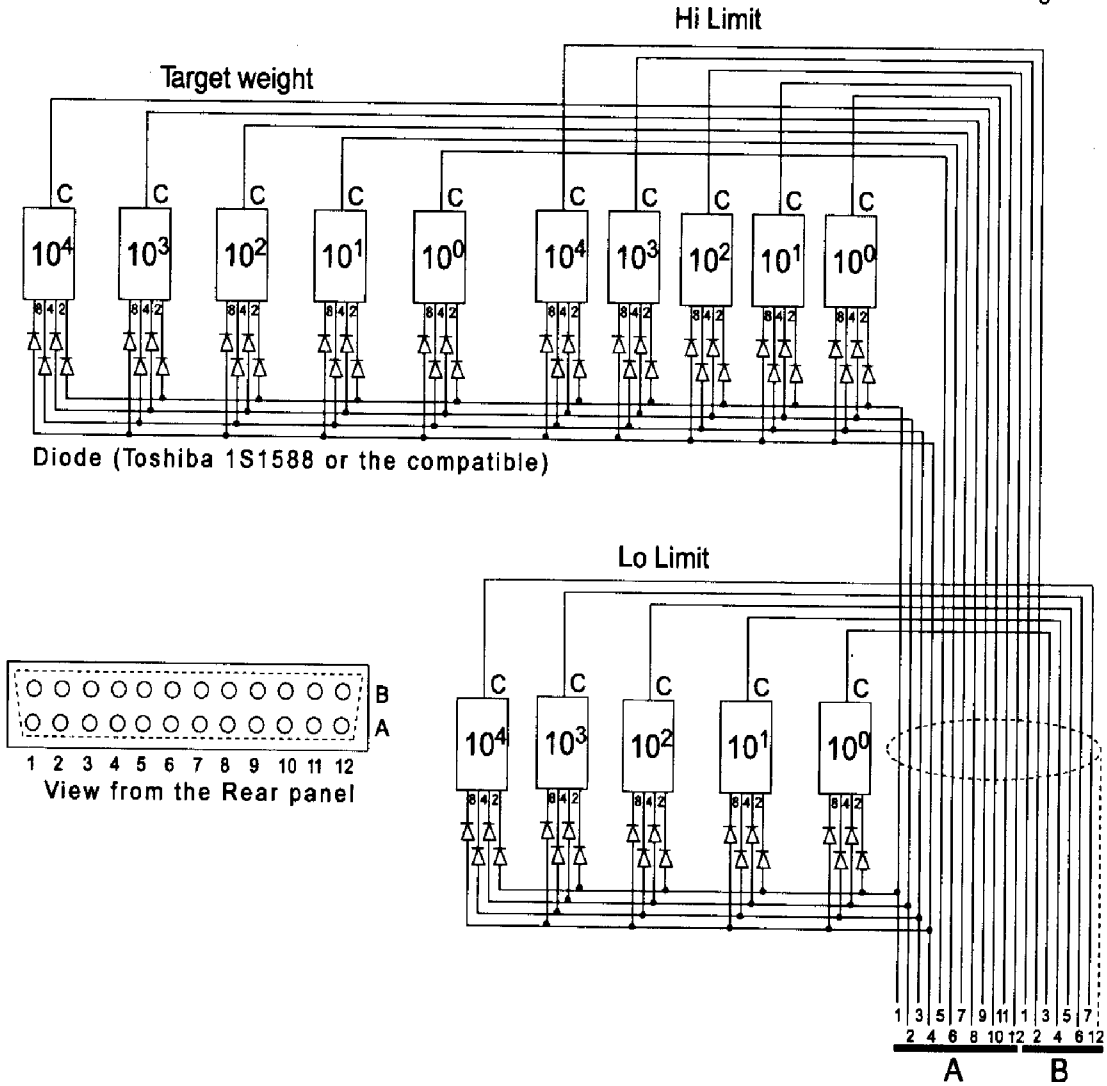

SETPOINT CONNECTOR WIRING

Pin #		Pin #	
A1	1	B1	Hi Limit. 10^3
A2	2	B2	Hi Limit. 10^4
A3	4	B3	Lo Limit 10^0
A4	8	B4	Lo Limit 10^1
A5	Target weight 10^0	B5	Lo Limit 10^2
A6	Target weight 10^1	B6	Lo Limit 10^3
A7	Target weight 10^2	B7	Lo Limit 10^4
A8	Target weight 10^3	B8	
A9	Target weight 10^4	B9	
A10	Hi Limit 10^0	B10	
A11	Hi Limit 10^1	B11	Used internally
A12	Hi Limit 10^2	B12	Shield

CHECK WEIGHING MODE 2 (WEIGHING MODE CALF-14 = 6)

Output Terminal	Output Condition
Zero band	Gross \leq Zero band
Hi-Hi	Net $>$ Hi-Hi Limit
Hi	Target Weight + Hi-Hi Limit \geq Net $>$ Target Weight
Go	Target Weight + Hi Limit \geq Net \geq Target Weight - Lo Limit
Lo	Target Weight - Lo-Lo Limit \leq Net $<$ Target Weight - Lo Limit
Lo-Lo	Net $<$ Lo-Lo Limit

When an output condition is established, a relevant output terminal is turned on (power continuity with output COM). An output terminal number can be selected with the general functions, OUTF-01 through OUTF-08.

The setpoint signal output is turned off unconditionally when the operation mode is other than the normal mode.

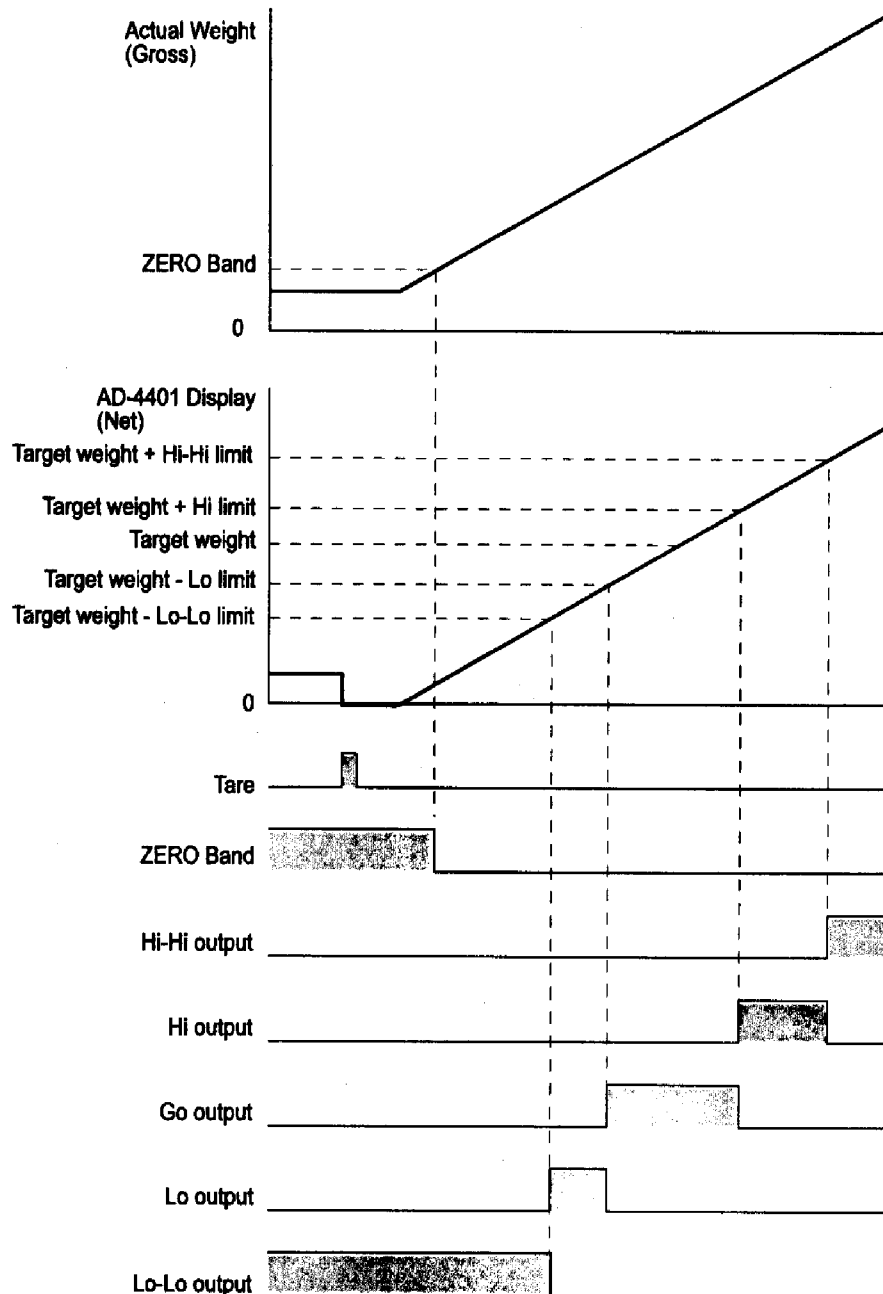

WHEN SETTING THE SETPOINT WITH A 15-DIGIT THUMBWHEEL SWITCH

When SPF-01 = 2 (16-digit mode) is set, connect the thumbwheel switch to the SET POINT connector as show in the figure below.

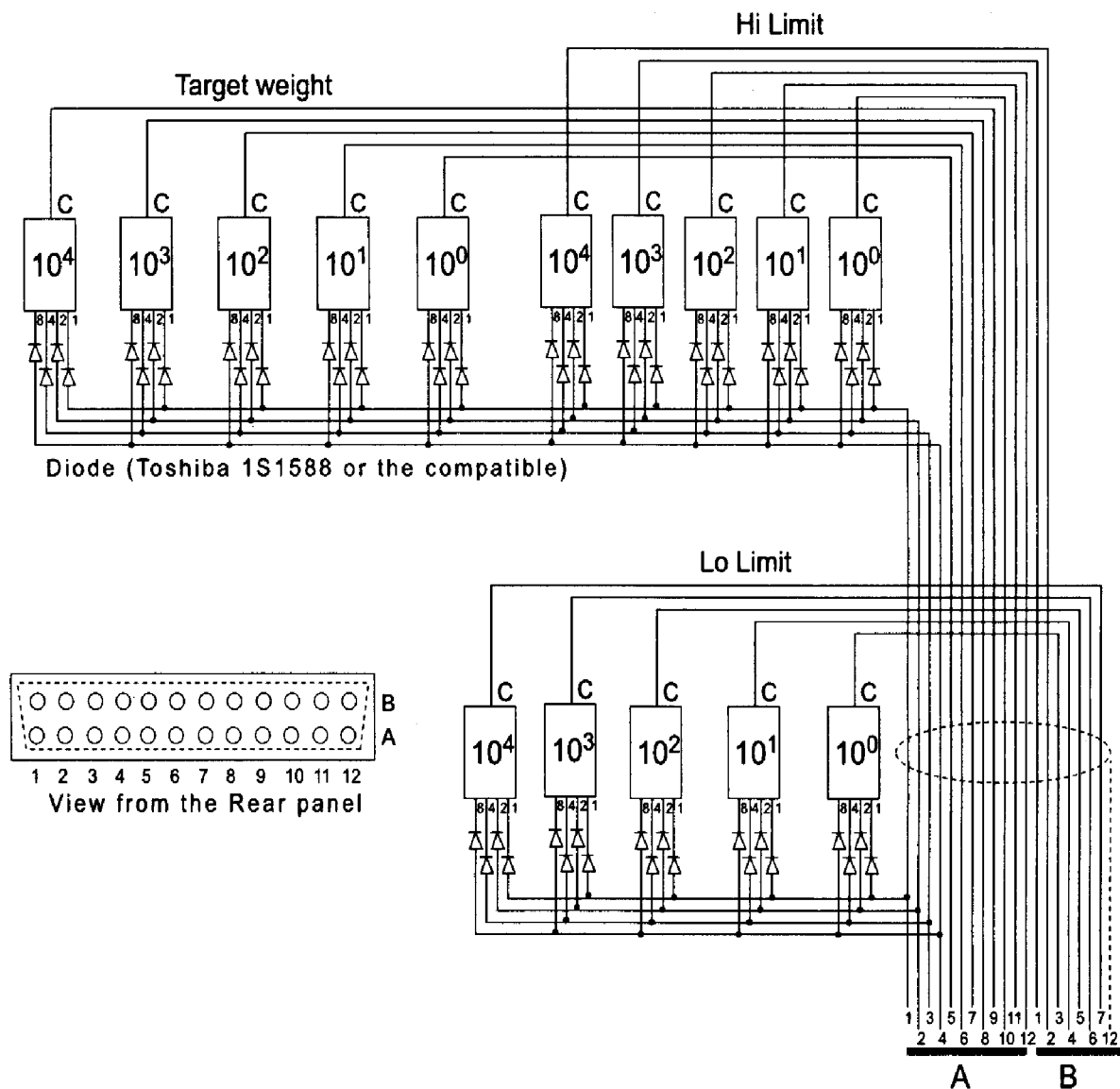

SETPPOINT CONNECTOR WIRING

Pin #		Pin #	
A1	1	B1	Hi Limit. 10^3
A2	2	B2	Hi Limit. 10^4
A3	4	B3	Lo Limit 10^0
A4	8	B4	Lo Limit 10^1
A5	Target weight 10^0	B5	Lo Limit 10^2
A6	Target weight 10^1	B6	Lo Limit 10^3
A7	Target weight 10^2	B7	Lo Limit 10^4
A8	Target weight 10^3	B8	
A9	Target weight 10^4	B9	
A10	Hi Limit 10^0	B10	
A11	Hi Limit 10^1	B11	Used internally
A12	Hi Limit 10^2	B12	Shield

CHECK WEIGHING MODE 3 (WEIGHING MODE CALF-14 = 7)

Output Terminal	Output Condition
Zero band	Gross \leq Zero band
Hi-Hi	Net $>$ Hi-Hi Limit
Hi	Net $>$ Hi Limit
Go	Hi Limit \geq Net \geq Lo Limit
Lo	Net $<$ Lo Limit
Lo-Lo	Net $<$ Lo-Lo Limit

When an output condition is established, a relevant output terminal is turned on (power continuity with output COM).

An output terminal number can be selected with the general functions, OUTF-01 through OUTF-08.

The setpoint signal output is turned off unconditionally when the operation mode is other than the normal mode.

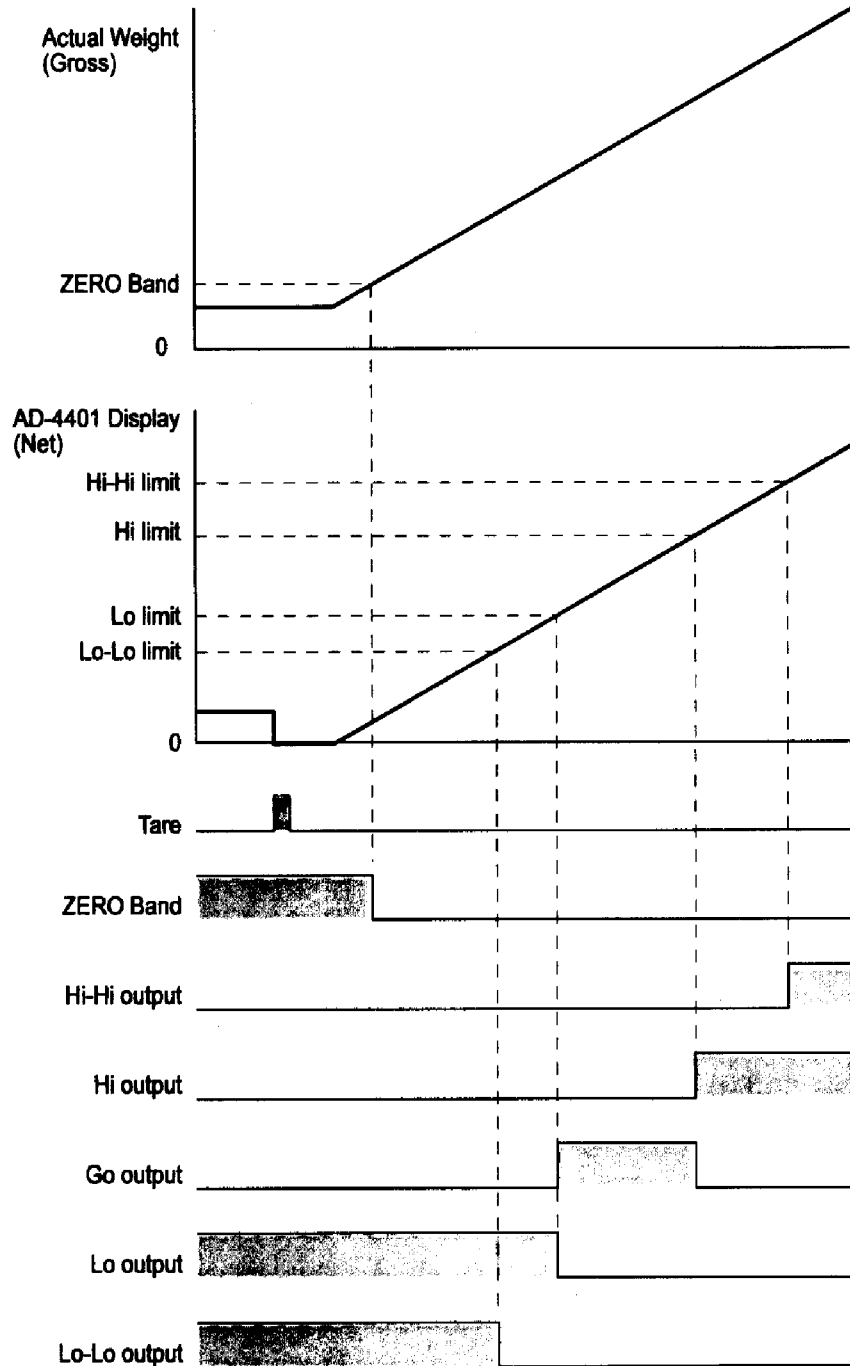

WHEN SETTING THE SETPOINT WITH A 10-DIGIT THUMBWHEEL SWITCH

When SPF-01 = 2 (16-digit mode) is set, connect the thumbwheel switch to the SET POINT connector as show in the figure below.

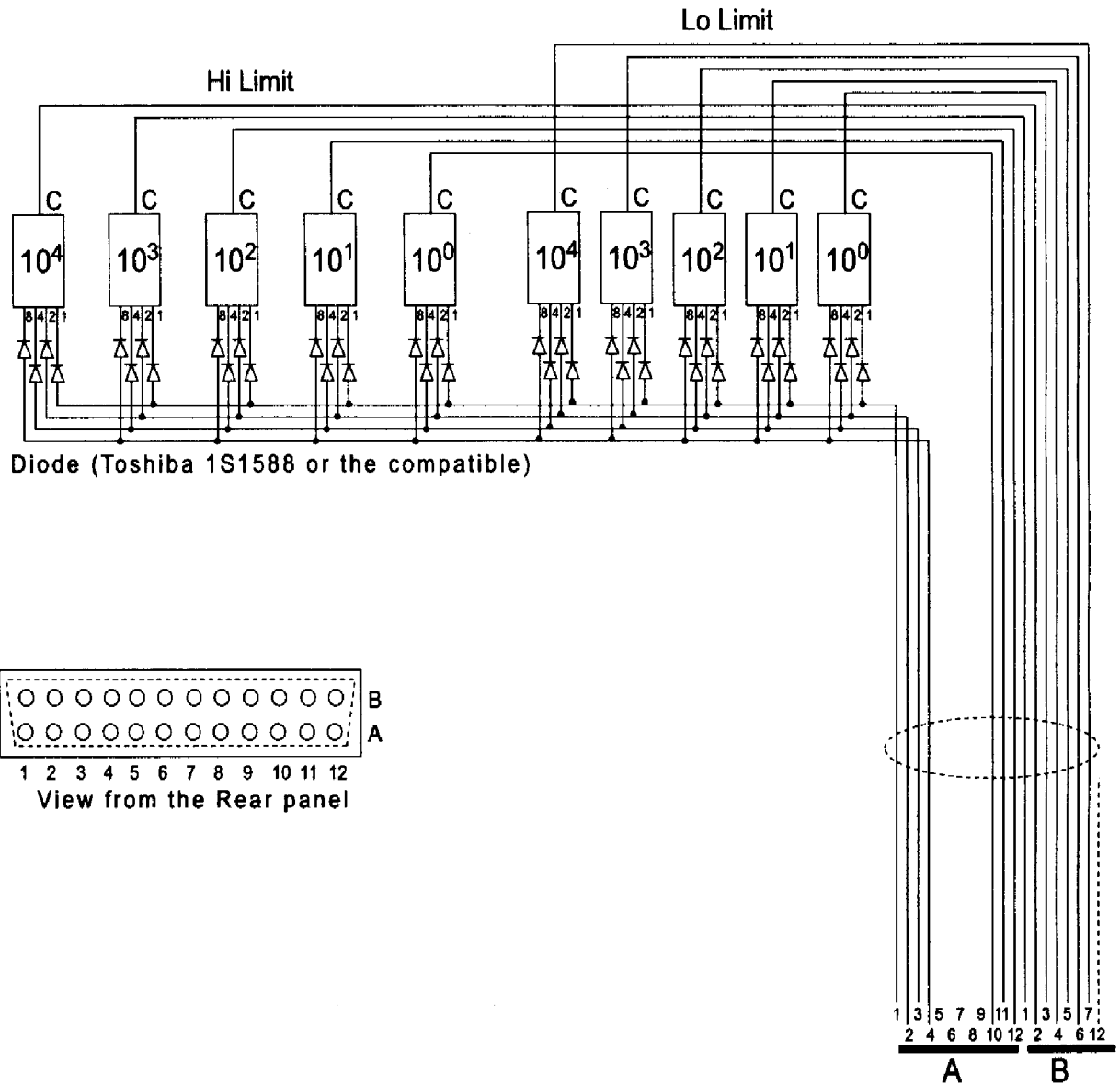

SETPOINT CONNECTOR WIRING

Pin #		Pin #	
A1	1	B1	Hi Limit. 10^0
A2	2	B2	Hi Limit. 10^4
A3	4	B3	Lo Limit 10^0
A4	8	B4	Lo Limit 10^1
A5		B5	Lo Limit 10^2
A6		B6	Lo Limit 10^3
A7		B7	Lo Limit 10^4
A8		B8	
A9		B9	
A10	Hi Limit 10^0	B10	
A11	Hi Limit 10^1	B11	Used internally
A12	Hi Limit 10^2	B12	Shield

CHECK WEIGHING MODE 4 (WEIGHING MODE CALF-14 = 8)

Output Terminal	Output Condition
Zero band	Gross \leq Zero band
Hi-Hi	Net $>$ Hi-Hi Limit
Hi	Hi Limit $>$ Net \geq Hi Limit
Go	Hi Limit \geq Net \geq Lo Limit
Lo	Lo Limit $>$ Net \geq Lo-Lo Limit
Lo-Lo	Net $<$ Lo-Lo Limit

When an output condition is established, a relevant output terminal is turned on (power continuity with output COM).

An output terminal number can be selected with the general functions, OUTF-01 through OUTF-08.

The setpoint signal output is turned off unconditionally when the operation mode is other than the normal mode.

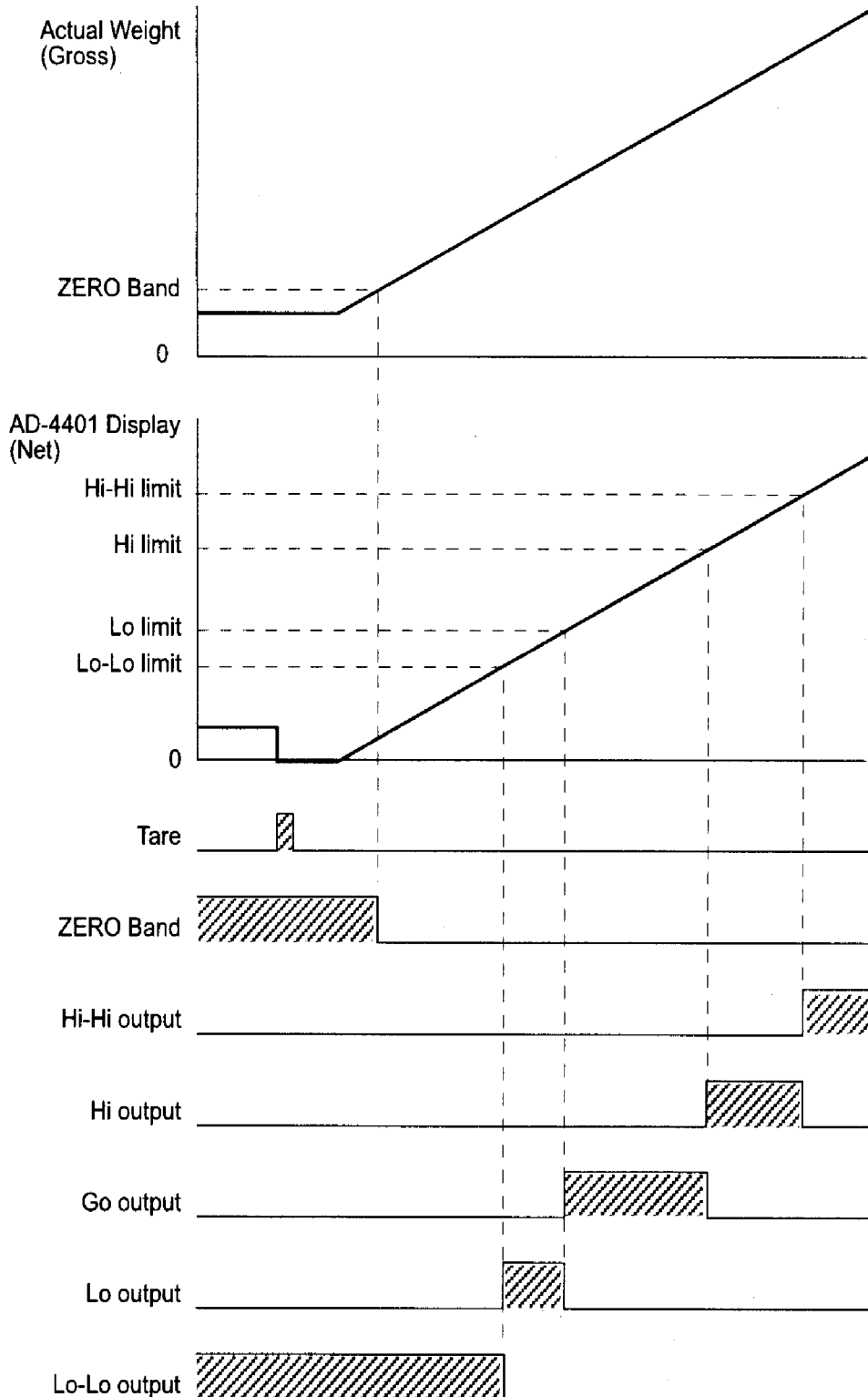

WHEN SETTING THE SETPOINT WITH A 16-DIGIT THUMBWHEEL SWITCH

When SPF-01 = 2 (16-digit mode) is set, connect the thumbwheel switch to the SET POINT connector as show in the figure below.

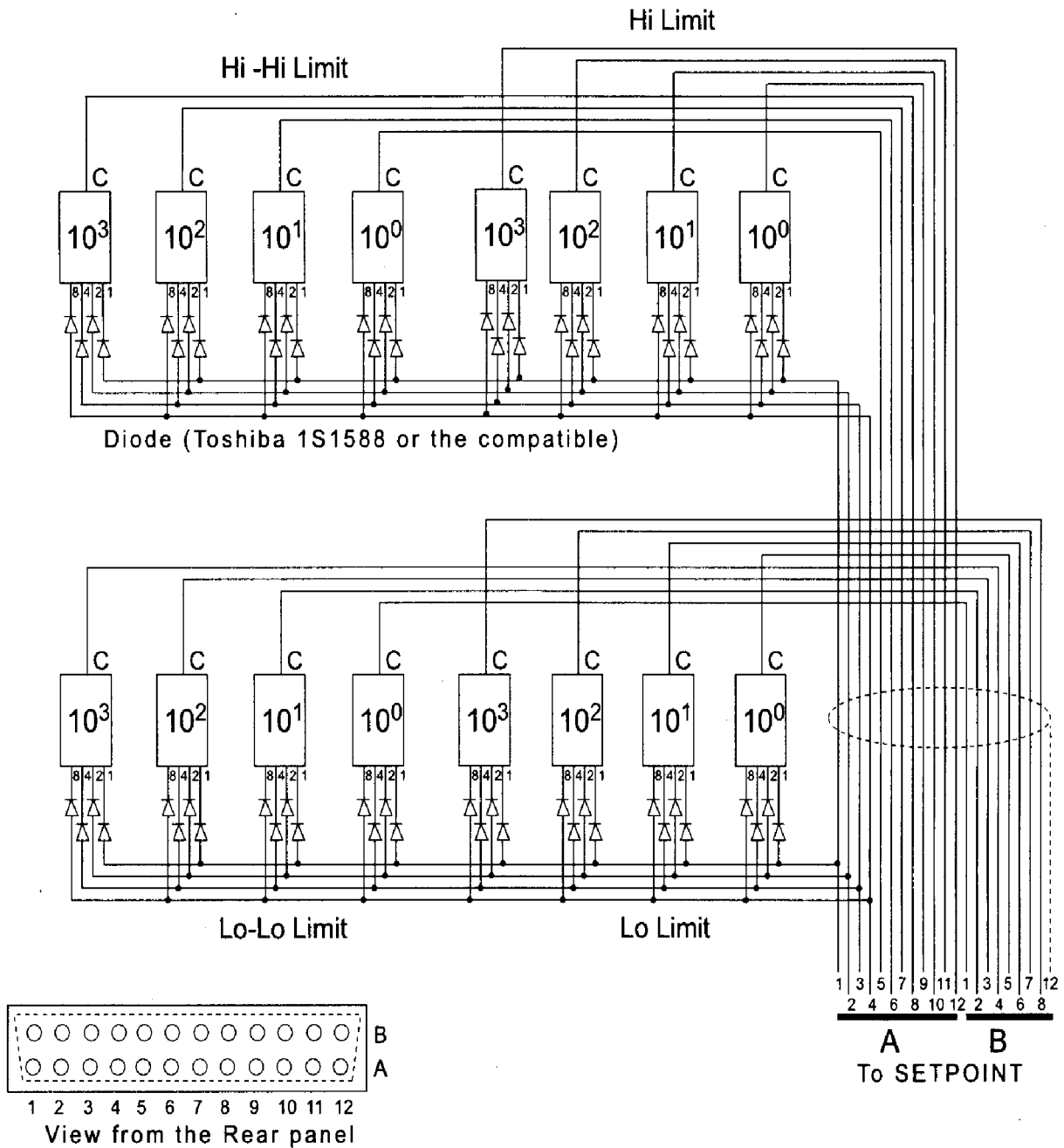

SETPOINT CONNECTOR WIRING

Pin #		Pin #	
A1	1	B1	Lo Limit 10 ⁰
A2	2	B2	Lo Limit 10 ¹
A3	4	B3	Lo Limit 10 ²
A4	8	B4	Lo Limit 10 ³
A5	Hi-Hi Limit 10 ⁰	B5	Lo-Lo Limit 10 ⁰
A6	Hi-Hi Limit 10 ¹	B6	Lo-Lo Limit 10 ¹
A7	Hi-Hi Limit 10 ²	B7	Lo-Lo Limit 10 ²
A8	Hi-Hi Limit 10 ³	B8	Lo-Lo Limit 10 ³
A9	Hi Limit 10 ⁰	B9	
A10	Hi Limit 10 ¹	B10	
A11	Hi Limit 10 ²	B11	Used internally
A12	Hi Limit 10 ³	B12	Shield

7-6 COMPARISON WEIGHT

Although the weight compared with the setpoint is mainly the net, the gross is partially compared. Since the net assumes a negative value in loss-in-weight, setpoint is made with the polarity reversed.

Setpoint of the weight with the setpoint allows you to select the display count and internal count.

One graduation of the weight value appearing in the display section is the minimum graduation set with CALF-03.

Provided internally is the weight value called high-resolution "internal count" with the minimum graduation calculated as 1.

For example, when the minimum graduation is 10, a display changes only in a step of 10, but a finer change is captured internally.

Batch weighing mode mainly uses the internal count, and Check comparison mode uses the display count.

This is because the internal count is superior from a viewpoint of weighing accuracy, but if the platform scale is compared using the internal count, it appears as if the displayed weight and comparison result are contradictory to each other.

The comparison weight is selected with the general function, "Selection of Setpoint Weight SQF-01." It is meaningless to use the internal count, unless the minimum graduation is 2 or more.

7-7 AUTO PRINT

Auto print is the capability to output the Batch Finish weight from the external output where the output mode has been set to Auto Print. The output timing is as follows depending on the weighing mode.

CUSTOMER PROGRAMMED CONTROL MODE (NORMAL BATCHING , LOSS-IN-WEIGHT)

Since the weighing completion timing is not definite in customer programmed control mode, the weight is output only once when a setpoint target net value is stabilized at 5D or greater.

To output again, the setpoint target net value must be to less than 5D (5 graduations).

BUILT-IN-AUTOMATIC PROGRAM MODE

The weight is output the moment the weighing sequence encounters the batch finish timing.

7-8 AUTOMATIC ACCUMULATION

The Automatic accumulation function automatically accumulates the net weight after weighing. The its timing is the same as auto print, but its functioning differs depending on "Automatic accumulation SQF-02."

SQF-	Name	Default	Setting	
			Parameter	Description
02	Automatic accumulation	0	0	No Automatic accumulation
			1	Accumulates only acceptable weight
			2	Accumulates all values

7-9 AUTOMATIC FREE FALL COMPENSATION

Automatic free fall compensation is the capability to reduce a loading error in batch weighing. The following two kinds can be selected depending on the functioning of the automatic free fall compensation (SQF-03).

- 1) Automatically setting the "moving average of the last four actual free falls" as the free fall for the next weighing.
- 2) Automatically adjusting free fall setting, applying fuzzy logic.

This section describes item 1; item 2 is described in 7-10.

The hopper scale has a certain increase in the weight value until batch finish since the dribble gate is closed. This increase is called a free fall. To perform weighing with little error, the free fall setting for the setpoint must be equal to an actual free fall.

As a remedy, there is an option to automatically update the "moving average of the last four actual free falls" as the next free fall setting. The loading error and actual free fall are expressed by the following formulas.

Error = Batch Finish net - final

Actual free fall = Batch Finish net - *Dribble flow cut net

* Final - Free fall

When the loading error exceeds the automatic free fall effective width (SQF-04), automatic free fall compensation is not performed, taking it as an error.

Since customer programmed control mode judges the Batch Finish timing externally, a calculation is made assuming that weighing is completed when an automatic free fall command is input to the Control I/O.

Automatic free fall compensation is designed to reduce the weighing error in batch weighing. Therefore, Check Weighing does not have this capability.

SQF-	Name	Default	Setting	
			Parameter	Description
03	Automatic Free Fall Compensation	0	0	No Automatic Free Fall Compensation
			1	Moving average of last four actual Free Falls
			2	Fuzzy Automatic Free Fall Compensation
04	Automatic Free Fall Effective Width	0	0 to 9999999	If a loading weight is within the final +/- automatic Free Fall effective width, Automatic Free Fall Compensation is on.

7-10 FUZZY AUTOMATIC FREE FALL COMPENSATION

Automatic free fall compensation mentioned above is very effective when the actual free fall does not change. However, it is very difficult for conventional automatic free fall compensation to eliminate the following actual free fall fluctuation factors.

- Changes of specific gravity or viscosity of the weighed substance
- Inconstant flow rate due to a change of water pressure, and so on
- Bad flow due to adherence of the weighed substance to the surface of the hopper
- Clumps in the weighed substance

Fluctuation factors mentioned above affect the actual free fall, but their relations are fuzzy.

The AD-4401 takes in their effects as the data 1 through 3 and reflects the fuzzy data in calculation of the free fall, applying fuzzy logic theory.

1) Flow rate and its change

- The actual free fall increases as the flow rate becomes greater.
- Reliability of the actual free fall becomes higher as a flow is stabilized.

2) Lapse of time

- The newest weighing result is least affected by a secular change.

3) Reliability of the loading result

- Higher reliability is given to the actual free fall where distribution of the loading result is more focused.

Note : Precautions for using Fuzzy Automatic Free Fall Compensation

- Fuzzy automatic free fall compensation is not made on the first loading after free fall setting for a setpoint.
- Take 3 seconds or more to carry out the dribble flow in order to calculate an internal flow rate.
- The free fall value always changes because it is calculated per sampling.

CHAPTER 8 INTERFACE

8-1 CONTROL I/O

The Control I/O is intended for inputting/outputting weighing control signals to an external unit. It consists of 6 inputs and 8 outputs.

The capability of each input/output terminal can be selected, except COM (see 6-3, 6-4 for selection method). Upon shipment, the Control I/O terminals were set for normal batching (Built-in Automatic Program Mode).

TERMINAL FUNCTIONS IN THE BUILT-IN AUTOMATIC PROGRAM MODE

Division	Terminal No.	Function Name	Description
Input	A1	Zero	Clears the gross to zero. However, it does not function beyond the range set with the calibration
	A2	Tare	Subtracting the tare weight and a displayed weight becomes the net.
	A3	Batch start	Starts the weighing sequence.
	A4	Emergency stop	Stops charging or discharging and turns on the output terminal set for the weighing sequence error.
	A5	Discharge start	Starts the discharging sequence.
	A6	Key enable	While this input is ON, the keys disabled by the general function (FNC-01) are enabled.
COM	A7	Input COM	Input COM. Each input is accepted by shorting it with this terminal.
	A8	Output COM	Output COM
Output	B1	Zero band	Turned on when the gross is lower than zero band setting.
	B2	Underlimit	Turned on when the judgment result is underlimit.
	B3	Overlimit	Turned on when the judgment result is overlimit.
	B4	Full flow	Turned on when the weighing sequence is full flow.
	B5	Medium flow	Turned on when the weighing sequence is medium flow.
	B6	Dribble flow	Turned on when the weighing sequence is dribble flow.
	B7	Discharge	Turned on during the discharging sequence.
	B8	Batch finish	Turned on when the weighing sequence is completed and judged.

CONTROL I/O CONNECTOR, ACCESSORY

Parts Name	Q'ty	A&D's parts Number	Description
Connector	1	J1-361J016-AG	FCN361J016-AU (or AG), Fujitsu
Connector cover	1	J1-360C016-B	FCN360C016-B, Fujitsu

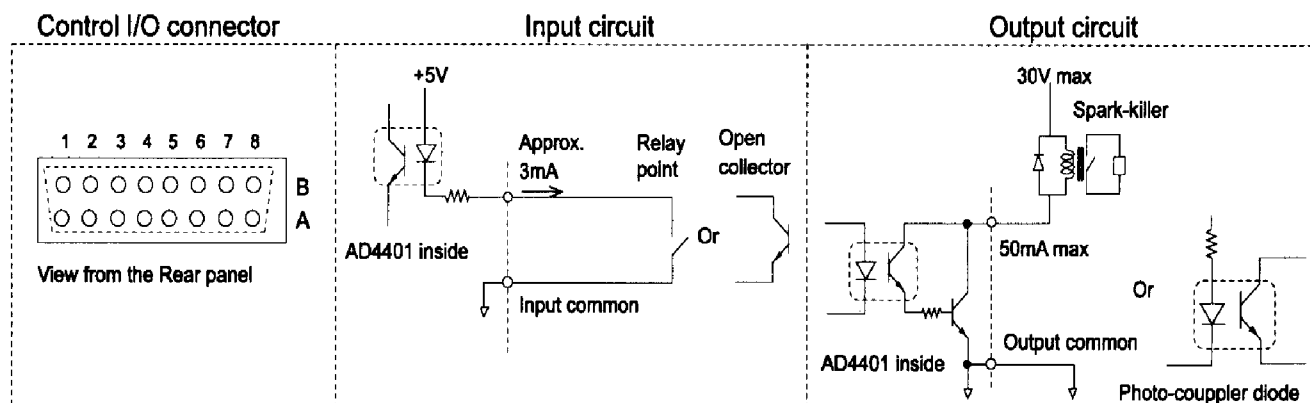

INPUT TERMINAL FUNCTION (INF-01 TO INF-06)

The capabilities of the input terminals A1 through A6 can be optionally selected with the “general functions INF-01 through INF-06.” (See 6-3 for method of selection)

Set value	Terminal No.	Function Name	Description	
0	<No function>	N/A	N/A	
1	Zero	Edge	Clears the gross to zero. However, it does not function beyond the condition set with the calibration.	
2	Tare	Edge	Subtracts the tare. A displayed weight becomes the net.	
3	Batch start	Edge	Starts the batch weighing.	For the Built-in automatic program mode.
4	Emergency stop	Level	Stops batching or discharging and turns on an output pin set for the weighing sequence error.	
5	Discharge start	Edge	Starts the discharging sequence. Exclusive for sequential batching	For Normal batching in the Built-in automatic program mode
6	Key enable	Level	While this input is turned on, the keys disabled by the general function(FNC-01) are enabled.	
7	Automatic free fall command	Edge	Performs automatic free fall compensation. Exclusive for customer programmed control mode	Normal batching & Loss-in weighing in the Customer programmed control mode
8	Digital switch read disable	Level	While this input is turned on, reading of the digital switch stops.	
9	Clear tare	Edge	Clears the tare value. A displayed value becomes the gross.	
10	Accumulation command	Edge	Accumulates the current net into the accumulated weight and increments the accumulated times by one.	
11	Accumulation cancel	Edge	Subtracts the previously accumulated weight from the accumulated weight and decrements the accumulate.	
12	Clear accumulation	Edge	Clears the accumulated weight and accumulated times.	
13	Hold	Level	While this input is turned on, the weight value is held.	
14	Print command for manual print	Edge	Outputs the specified data from the external input/output set for manual print.	

- Note 1: An edge input is accepted when it is switched from OFF to ON, and a level input is accepted while it is ON.
- Note 2: Input ON refers to the state when each input terminal and input COM are connected together.
- Note 3: An input has chattering eliminated. Both ON time and OFF time require 50 ms or more. In order to prevent malfunctioning, each input terminal does not accept an input in the non-normal mode such as “before displaying the weight after power-on” or “OFF mode.”

OUTPUT TERMINAL FUNCTION (OUTF-01 TO OUTF-08)

Output terminals B1 through B6 can be optionally selected with the "general functions OUTF-01 through OUTF-08." (See 6-4.)

Set value	Function Name	Description
0	No function	N/A
1	Zero range	Turned on when the gross is close to the zero range.
2	Underlimit	In case of Normal batching/Loss-in-weight
	Hi-Hi	In case of check weighing
3	Overlimit	In case of Normal batching/Loss-in-weight
	Hi	In case of check weighing
4	Full flow	In case of normal batching
	Full	In case of Loss-in-weight
	Go	In case of check weighing
5	Medium flow	In case of Normal batching / Loss-in-weight
	Lo	In case of check weighing
6	Dribble flow	In case of Normal batching / Loss-in-weight
	Lo-Lo	In case of check weighing
7	Discharge	Exclusive for built-in automatic program
8	Batch finish	
9	Motion detection	Turned on when the weight value is stabilized.
10	Online	Turned on in case of the normal mode
11	Weighing sequence running	Turned on when waiting for an input of the loading signal.
12	Weighing sequence error	Turned on when a weighing sequence error occurs.
13	Input acknowledge	Turned on for 0.5 second after detecting a rise edge of the input terminal.
14	Zero error	Turned on when zeroing was performed and could not be accepted because it was beyond the condition.
15	Capacity overflow	Turned on when the gross overflows.
16	Low battery	Turned on when the memory backup battery has run out.

Functioning differs depending on the weighing mode CALF-14. See CHAPTER 7 WEIGHING SEQUENCE.

Exclusive for built-in automatic program

Note 1: Output ON refers to the state that the open collector circuit for each output and output COM have power continuity. (See 8-1 for circuit description)
In order to prevent malfunctioning, each output terminal is turned off in the non-normal mode such as "before displaying the weight after power-on" or "OFF mode."

8-2 SETPOINT

The setpoint refers to a weight setting such as the reference value and final required for the weighing sequence.

Connect the thumbwheel switch which makes this setting to the SET POINT connector.

Connection of the setpoint differs depending on the general function, "Setpoint Read Mode (SPF-01)." It also differs depending on the weighing mode.

THUMBWHEEL SWITCH NOT REQUIRED MODES; SPF-01 = 1

You do not have to connect anything to the SET POINT connector. (Setting upon shipment)

5-DIGIT MODE; SPF-01 = 1

When the minimum graduation is set to 10 or more, the value of the thumbwheel switch is input and multiplied by 10.

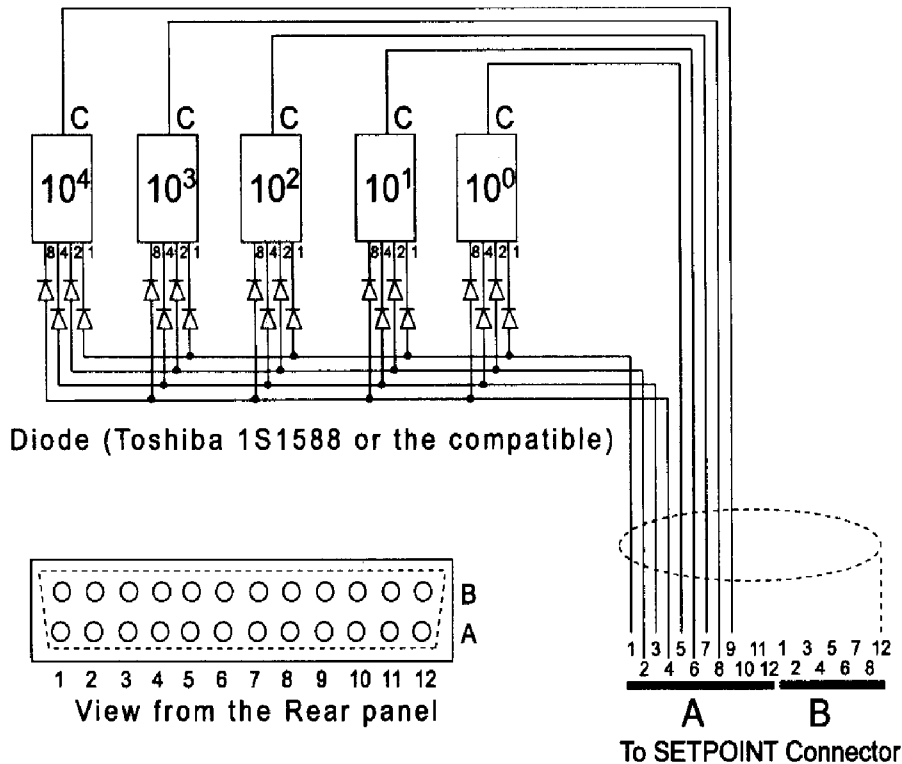

Pin #	
A1	1
A2	2
A3	4
A4	8
A5	Final 10 ⁰
A6	Final 10 ¹
A7	Final 10 ²
A8	Final 10 ³
A9	Final 10 ⁴
B12	Shield

Only use the pins listed above.
When the minimum graduation is set to 10 or more, the value of the thumbwheel switch is input and multiplied by 10.

CONNECTOR FOR SETPOINT (NOT INCLUDED WITH THE ACCESSORIES.)

Parts Name	Q'ty	A&D's parts Number	Description
Connector	1	J1-361J024-AG	FCN361J024-AU(or AG), Fujitsu
Connector cover	1	J1-360C024-B	FCN360C024-B, Fujitsu

16-DIGIT MODE; SPF-01 = 2

Depends on the weighing mode. See {CHAPTER 7. WEIGHING SEQUENCE}

When the minimum graduation is set to 10 or more, the value of the thumbwheel switch is input and multiplied by 10.

8-3 STANDARD SERIAL OUTPUT (SER. OUT)

The standard serial output is a 20 mA current loop. It is located on the rear panel of the indicator, and is used to connect a remote indicator or printer. This output does not have a power supply. Therefore, the external unit must supply the power.

Setting of the standard serial output is done with the general functions, SIF-01 through SIF-03.

CONNECTOR FOR STANDARD SERIAL OUTPUT (INCLUDED WITH THE ACCESSORIES.)

Parts Name	Q'ty	A&D's parts Number	Description
Connector	1	JA-TCP0576	TCP0576, Hoshi Electric

Output circuit

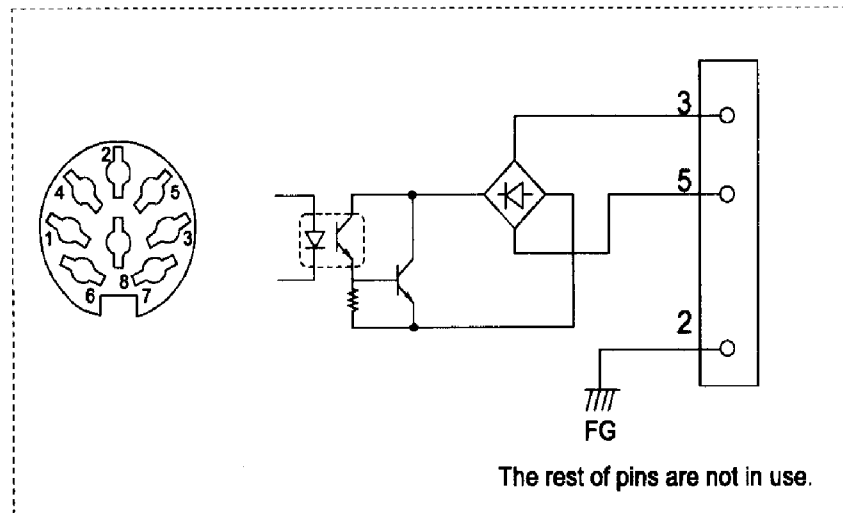

SIF-	Name	Default	Setting		
			Parameter	Description	
01	Output data	1	1	Displayed weight	A&D standard format
			2	Gross	
			3	Net	
			4	Tare	
			5	Gross/Net/Tare	
			6	Accumulated weight	Accumulated data format
			7	Accumulated counts	
			8	Accumulated weight/ Accumulated counts	
02	Data transfer mode	1	1	Stream	
			2	Auto print	
			3	Manual print	
03	Baud rate	2	1	600 bps	
			2	2400 bps	

INTERFACE SPECIFICATION

Signal System	20 mA current loop 1=20 mA, 0=0 mA
Data bit	7 bits
Parity bit	1 bit (EVEN)
Stop bit	1 bit
Code used	ASCII

Note: When connecting any unit other than an external indicator or printer manufactured by A & D, the device must supply power (active current loop) or an external power supply must be used.

OUTPUT DATA

There are two kinds of transmission formats; "A & D standard format" and "Accumulation data format".

The A & D standard format has been used for our weighing indicators. It consists of two headers, data, unit, and terminator. The Accumulation data format outputs a simple header, numerical data, unit and terminator. The following shows their examples.

< A & D STANDARD FORMAT >

Header 1		Header2		Data (Eight digits; polarity and decimal point included)								Unit		Terminators		
S	T	,	G S	,	+	0	0	1	2	3	4	5	k	g	CR	LF

	ASCII code	Hexadecimal number	Description
Header-1	ST	[53 54]	(STable)
	US	[55 53]	(UnStable)
	OL	[4F 4C]	(Over Load)
Header-2	GS	[47 53]	(GroSs)
	NT	[4E 54]	(NeT)
	TR	[54 52]	(TaRe)
Separator	,	[2C]	
Data (ASCII code)	0 to 9	[30 to 39]	
	+	[2B]	
	-	[2D]	
	SP (space)	[20]	
	.	[2E]	
Unit	SP SP	[20 20]	(No unit)
	SP g	[20 67]	(g)
	kg	[6B 67]	(kg)
	SP t	[20 74]	(t)
	lb	[6C 62]	(lb)

< Example >

	Header 1		Header 2		8 Digits Including Data, Polarity, and Decimal Point								Unit		Terminator			
Gross	S	T	,	G S	,	+	0	0	1	2	3	4	5	k	g	CR	LF	Header-2 is "GS"
Net	S	T	,	N T	,	+	0	0	1	0	0	0	0	k	g	CR	LF	Header-2 is "NT"
Tare	S	T	,	T R	,	+	0	0	0	2	3	4	5	k	g	CR	LF	Header-2 is "TR"
With decimal point	S	T	,	G S	,	+	0	1	2	3	.	4	5	k	g	CR	LF	"." in numerical data
Plus overflow	O	L	,	G S	,	+	SP	SP	SP	SP	.	SP	SP	k	g	CR	LF	Header-1 is "OL"
Minus overflow	O	L	,	G S	,	-	SP	SP	SP	SP	.	SP	SP	k	g	CR	LF	Header-1 is "OL" and polarity is "-"
Unstable	U	S	,	G S	,	+	0	1	2	3	.	4	5	k	g	CR	LF	Header-1 is "US"
Output OFF data	O	L	,	G S	,	+	SP	SP	SP	SP	.	SP	SP	k	g	CR	LF	Same as plus overflow

<ACCUMULATION DATA FORMAT>

< Example >

	Header-1		8 Digits Including Data, Polarity, and Decimal Point											Unit		Terminator			
Accumulated weight	T	W	,	+	0	1	2	3	4	5	6	.	7	8	k	g	CR	LF	Header is "TW"
Weight + Overflow	T	W	,	+	SP	SP	SP	SP	SP	SP	SP	.	SP	SP	k	g	CR	LF	"SP" value
Weight - Overflow	T	W	,	-	SP	SP	SP	SP	SP	SP	SP	.	SP	SP	k	g	CR	LF	"SP" value, "-" polarity
Accumulated count	T	N	,	+	0	1	2	3	4	5	6	7	8	9	SP	SP	CR	LF	Header is "TN"
Counts + Overflow	T	N	,	+	SP	SP	SP	SP	SP	SP	SP	.	SP	SP	SP	SP	CR	LF	"SP" value

[Stream]

The data is transmitted in synchronization with the update of the display. When the display rewrite exceeds the baud rate, data transmission is suspended until the next display update.

The transmitted data is the same as what is being displayed. Therefore, non-displayed data is never transmitted.

[Auto Print]

The data is transmitted each time weighing has been completed. The weighing completion timing differs depending on the weighing mode. See CHAPTER 7 WEIGHING SEQUENCE.

[Manual Print]

The data is transmitted when you press the key set for the "print command for manual print" or a Control I/O input is made.

CHAPTER 9 OPTIONS

There are the following external input/output options.

Note) The 4401 has only one slot for OP-01, OP-03 or OP-04. Therefore only one of them can be installed.

- OP-01 BCD output
- OP-03 RS-422/-485 input/output
- OP-04 RS-232C input/output
- OP-05 Setpoint unit (Setpoint setting thumbwheel switch, common to the AD4323)
- OP-07 Analog output (100 times/sec. high-speed output, can be scaled optionally)

9-1 OP-01 PARALLEL BCD OUTPUT

Setting of the BCD output is done with the general functions, BCDF-01 through BCDF-05.

BCDF-	Name	Default	Setting	
			Parameter	Description
01	Output data	1	1	Displayed weight
			2	Gross
			3	Net
			4	Tare
02	Data transfer mode	1	1	Stream
			2	Auto print
			3	Manual print
03	Data output logic	2	1	Positive logic
			2	Negative logic
04	Strobe output logic	2	1	Positive logic
			2	Negative logic

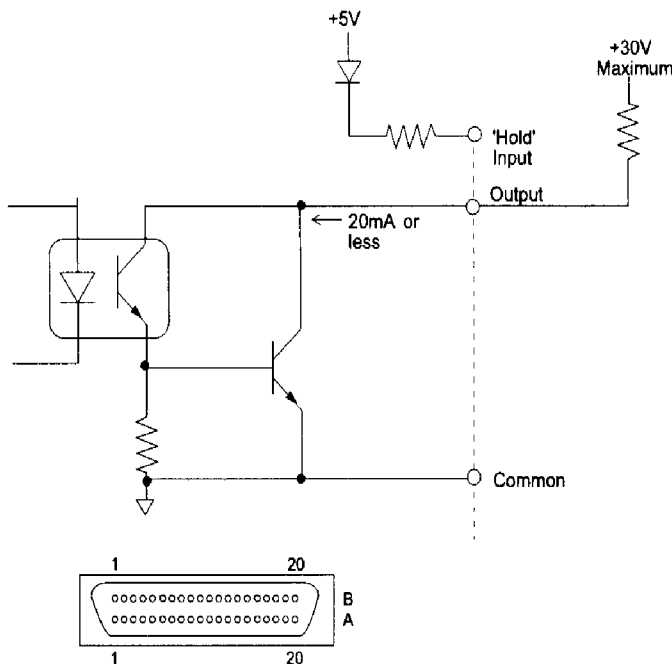

CONNECTOR FOR OP-01 BCD OUTPUT (INCLUDED WITH THE OP-01 ACCESSORIES.)

Parts Name	Q'ty	Parts Number	Description
Connector	1	J1-361J040-AG	FCN361J040-AU (or AG), Fujitsu
Connector cover	1	J1-360C040-B	FCN360C040-B, Fujitsu

INTERFACE SPECIFICATION

Output	Open collector (Common is connected to the NPN transistor emitter sides) Output data: 6-digit BCD code, overflow, polarity, motion, strobe
Input	Dry contact (Pulled up to +5 V by a resistor) Input data: Hold

- In case of negative logic, each terminal is turned on at "1". "ON" refers to the state that there is power continuity between the terminal and GND.
Example: The B14 terminal is turned on in NET.
- In case of overflow the digits, 1×10^0 to 1×10^5 of the weighing data become "1".
- Hold-input is fixed at negative logic. All outputs including strobe are held when HOLD input is turned on.

Pin #		Pin #	
A1	1×10^0	B1	2×10^0
A2	4×10^0	B2	8×10^0
A3	1×10^1	B3	2×10^1
A4	4×10^1	B4	8×10^1
A5	1×10^2	B5	2×10^2
A6	4×10^2	B6	8×10^2
A7	1×10^3	B7	2×10^3
A8	4×10^3	B8	8×10^3
A9	1×10^4	B9	2×10^4
A10	4×10^4	B10	8×10^4
A11	1×10^5	B11	2×10^5
A12	4×10^5	B12	8×10^5
A13	OVER	B13	Positive
A14	Motion Detect	B14	Net
A15	Decimal Point 10^1	B15	Decimal Point 10^2
A16	Decimal Point 10^3	B16	Decimal Point 10^4
A17	* Unit 1	B17	* Unit 2
A18	Strobe	B18	Hold-Input
A19	Common	B19	Common
A20	FG	B20	FG

*Unit 1, Unit 2

Unit	Unit 1	Unit 2
None	0	0
kg	0	0
lb	1	0
t	0	1
g	1	1

DATA TRANSFER MODE

There are three kinds of data transfer modes for the BCD output; "stream," "auto print," and "manual print."

[Stream], [Auto Print], and [Manual Print]

The functions of these transfer modes are the same as described in {8-3 Standard Serial Output}.

TIMING

Strobe pulses are turned on approximately 7 ms after rewriting the output data and turned off in 17 ms.

If a hold input is turned on, an update of the output data will stop within 50 ms.

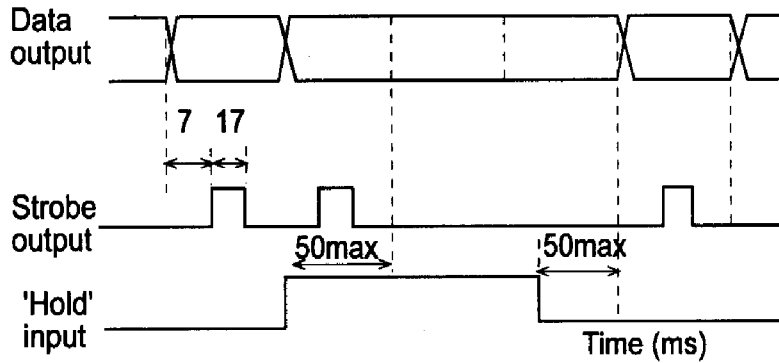

9-2 OP-03 RS-422/-485 INTERFACE

OP-03 provides external inputs/outputs to be connected to a personal computer. It can be set to RS-422 or RS-485. It is different from the RS-232C in that up to 10 units can be connected in series (RS-422) or parallel (RS-485) by the address capability. The data format, function settings, and so on are common to the OP-04 RS-232C.

Signal System	Conforms to the EIA RS-422 or RS-485
Data bits	7 bits, 8 bits
Parity bits	1 bit (Even or Odd), None
Stop bits	1 bit, 2 bits
Baud rate	600, 1200, 2400, 4800, 9600, 19200 bps
Code used	ASCII

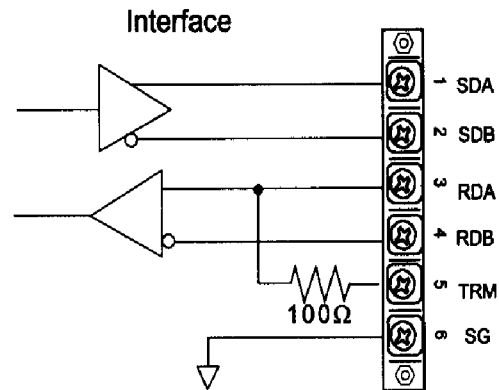

If terminator resistors are used, place them between TRM and RDB.

ADDRESS CAPABILITY

The address capability responds only when your own instrument is called from a host computer. The address number of each instrument can be set from 1 to 99 with RSF-09; 0 denotes no address capability.

When a command prefixed with an address "@xx"(xx is an address number) is sent from the host computer, each AD-4401 compares this with address setting of the individual instrument.

If a result of setpoint matches, the command will be analyzed and responded to. At this time, the instrument's address is added to the response.

Example of Adding the Address (For MZ Command)

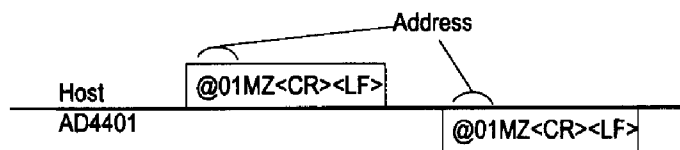

SWITCHING TO RS-422/RS-485

Switching to RS-422/RS-485 is made with RSF-08. When more than two units are connected to the AD-4401, select " Command " for RSF-02 and " With address " for RSF-09.

<EXAMPLE>

RS-422 (RSF-08=1)

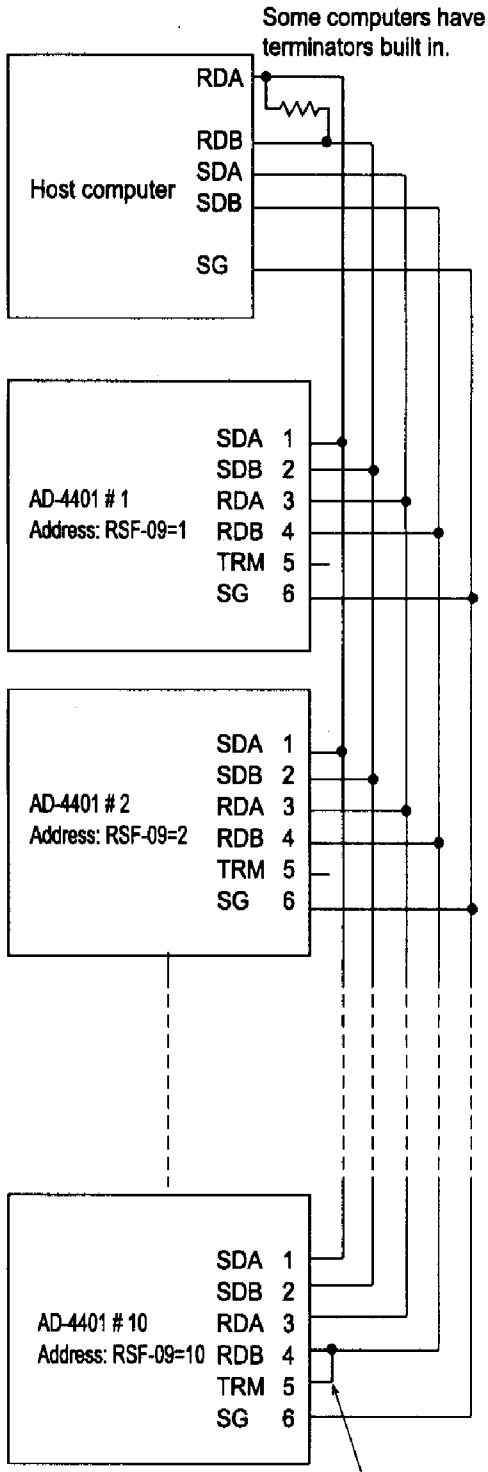

RS-485 (RSF-08=2)

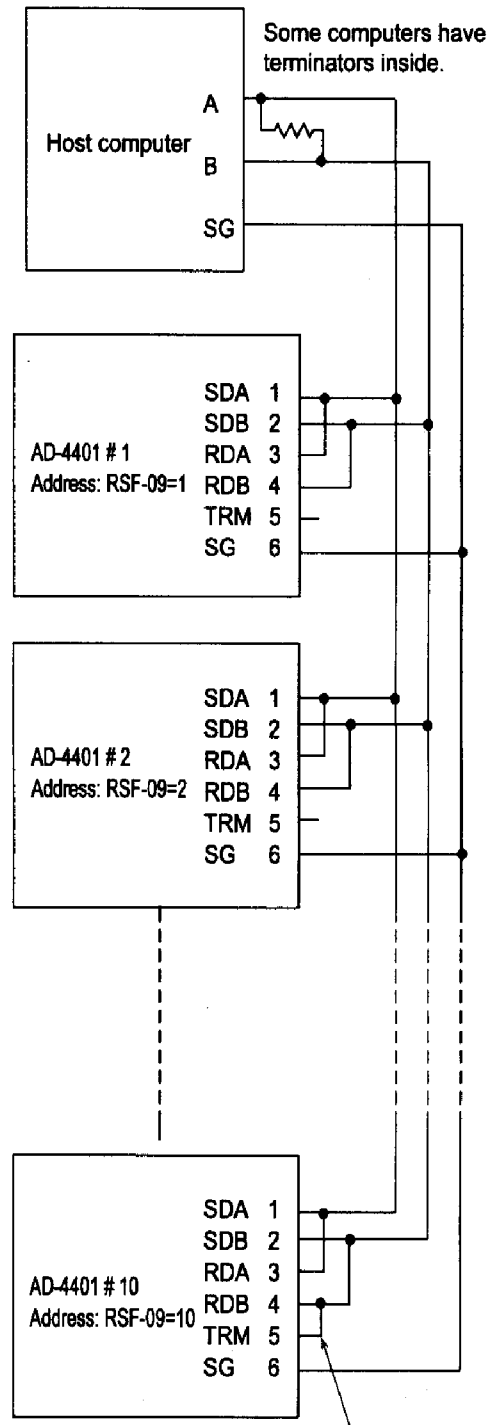

Note:

- The polarity of signal A and B vary from computers.
- Not necessary to ground the SG terminal for the computer without a signal ground terminal.
- Wait 8 ms or more before selecting a unit by SDA and SDB.

<EXAMPLE>

The following is a program for connecting two AD-4401s and a computer by RS-422.

Setting item	Computer	AD-4401
Baud rate	960 0 bps	RSF-03 = 5
Parity bit	Even	RSF-04 = 2
Character bit	7 bits	RSF-05 = 7
Stop bit length	1 bit	RSF-06 = 1
Terminator	CR, LF	RSF-07 = 2
Output data (Display weight)	N/A	RSF-01 = 1
Data transmitting mode (Command)		RSF-02 = 4
RS-422/485 switching (RS-422)		RSF-08 = 1
Address number		RSF-09 = 1 (#1) RSF-09 = 2 (#2)

```

10  OPEN "COM:E71NN" AS#1      RS-232C stand-by
20  PRINT #1,"@01RW"          Data request for AD-4401 #1
30  LINE INPUT #1,A1$         Data receive from AD-4401 #1
40  PRINT A1$                  Displaying the data from AD-4401 #1
50  FOR I=1 TO 100: NEXT I    Waiting for the next
60  PRINT #1,"@02RW"          Data request for AD-4401 #2
70  LINE INPUT #1,A2$         Data receive from AD-4401 #2
80  PRINT A2$                  Displaying the data from AD-4401 #2
90  CLOSE
100 END

```

9-3 OP-04 RS-232C INPUT/OUTPUTS

OP-04 provides external inputs/outputs to be connected to an external indicator, printer, personal computer, etc. It has both RS-232C inputs/outputs and current loop outputs. Current loop outputs and RS-232C outputs are internally connected in parallel.

INTERFACE SPECIFICATION

Signal System	Conforms to the EIA RS-232C
Data bits	7 bits, 8 bits
Parity bits	1 bit (Even or Odd), None
Stop bits	1 bit, 2 bits
Baud rate	600, 1200, 2400, 4800, 9600, 19200 bps
Code used	ASCII

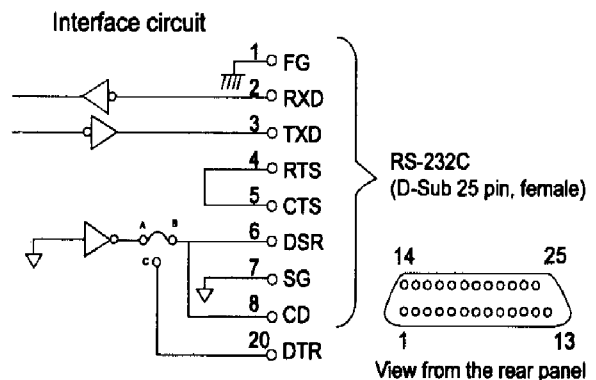

Note: OP-04 settings are made with RSF-01 through RSF-07. These settings are common to OP-03 (RS-422/485). OP-04 RS-232C I/O connector, not included. Use the one below or the compatible on the market.
D-Sub 25P Plug: HDBB-25P, Hirose
Connector cover: HDB-CTF, Hirose

RSF-	Name	Default	Setting		
			Parameter	Description	
01	Output data	1	1	Displayed weight	A&D standard format
			2	Gross	
			3	Net	
			4	Tare	
			5	Gross/Net/Tare	Accumulated data format
			6	Accumulated weight	
			7	Accumulated counts	
			8	Accumulated weight/ Accumulated counts	
02	Data transfer mode	1	1	Stream	Set to 9600 bps or less at the time of output per sampling.
			2	Auto print	
			3	Manual print	
			4	Command	
			5	Comparison data + Gross ; Output per sampling	
			6	Comparison data + Net; Output per sampling	
03	Baud rate	5	1	600 bps	
			2	1200 bps	
			3	2400 bps	
			4	4800 bps	
			5	9600 bps	
			6	19200 bps	
04	Parity	2	0	None	
			1	Odd	
			2	Even	
05	Character bit length	7	7	7 bits	
			8	8 bits	
06	Stop bit length	1	1	1 bit	
			2	2 bit	
07	Terminator	2	1	CR	
			2	CR LF	
08	RS-422/RS-485 switching	1	1	RS-422	This setting is invalid when the RS-232C is used.
			2	RS-485	
09	Address number	0	0	Without address capability 01-99: With address capability	Set to 0 in case of the RS-232C.
			01 to 99	With address capability	

DATA TRANSFER MODE

There are five kinds of data transfer modes for RS-232C/422/485; "stream," "auto print," "manual print," "command", and "output per sampling."

[Stream], [Auto Print], and [Manual Print]

The functions of these transfer modes are the same as described in 8-3 Standard Serial Output.

[Command]

This mode analyzes the "command" received from the host computer, etc. provides relevant processing, and responds with a result. For example, if an "MT" command is received, the tare will be subtracted and its result (whether tare subtraction is allowed or not) will be sent as a response.

The address capability is available only in this mode.

[Output per Sampling]

There are two types; gross and net. This mode outputs the setpoint state as well as weights. This is stream operations outputting at a rate of 100 times/second in synchronization with sampling.

TRANSMISSION FORMAT

There are three kinds of transmission format; "A & D standard format", "Accumulation data format", and "Output-per-Sampling format." (Outputs data 100 times per second synchronized with sampling.)

The A & D standard format used for this weighing indicator consists of two headers, data, unit, and a terminator.

A & D Standard Format Example

	Header-1			Header-2			8 Digits Including Data, Polarity, and Decimal Point								Unit		Terminator		
Gross	S	T	,	G	S	,	+	0	0	1	2	3	4	5	k	g	CR	LF	Header-2 is "GS"
Net	S	T	,	N	T	,	+	0	0	1	0	0	0	0	k	g	CR	LF	Header-2 is "NT"
Tare	S	T	,	T	R	,	+	0	0	0	2	3	4	5	k	g	CR	LF	Header-2 is "TR"
With decimal point	S	T	,	G	S	,	+	0	1	2	3	.	4	5	k	g	CR	LF	"." in numerical data
Plus overflow	O	L	,	G	S	,	+	SP	SP	SP	SP	.	SP	SP	k	g	CR	LF	Header-1 is "OL"
Minus overflow	O	L	,	G	S	,	-	SP	SP	SP	SP	.	SP	SP	k	g	CR	LF	Header-1 is "OL" and polarity is "-"
Unstable	U	S	,	G	S	,	+	0	1	2	3	.	4	5	k	g	CR	LF	Header-1 is "US"
Output OFF data	O	L	,	G	S	,	+	SP	SP	SP	SP	.	SP	SP	k	g	CR	LF	Same as plus overflow

Accumulation data format Example

	Header -1		8 Digits Including Data, Polarity, and Decimal Point											Unit		Terminator			
Accumulated weight	T	W	,	+	0	1	2	3	4	5	6	.	7	8	k	g	CR	LF	Header is "TW"
Weight + Overflow	T	W	.	+	SP	SP	SP	SP	SP	SP	SP	.	SP	SP	k	g	CR	LF	"SP" value
Weight - Overflow	T	W	.	-	SP	SP	SP	SP	SP	SP	SP	.	SP	SP	k	g	CR	LF	"SP" value, "-" polarity
Accumulated count	T	N	,	+	0	1	2	3	4	5	6	7	8	9	SP	SP	CR	LF	Header is "TN"
Counts + Overflow	T	N	.	+	SP	SP	SP	SP	.	SP	SP	.	SP	SP	SP	SP	CR	LF	"SP" value

*The decimal point position remains unchanged in case of overflow.

Output-per-Sampling Format Example

	Setpoint data		Weight data, Hexadecimal, 6 digits						Terminator																																																																																																													
Gross/ Net	3	0	0	0	2	7	1	0	CR	LF																																																																																																												
+ Overflow	0	0	7	F	F	F	F	F	CR	LF	Weight data [7FFFFFF]																																																																																																											
- Overflow	0	1	8	0	0	0	0	0	CR	LF	Weight data [800000]																																																																																																											
Output Off data	0	0	7	F	F	F	F	F	CR	LF	Same as + Overflow																																																																																																											
<table border="1" style="width: 100%; border-collapse: collapse;"> <tr> <td style="width: 10%;">0</td> <td style="width: 10%;">0</td> <td style="width: 10%;">1</td> <td style="width: 10%;">0</td> <td style="width: 10%;">1</td> <td style="width: 10%;">1</td> <td style="width: 10%;">0</td> <td style="width: 10%;">0</td> <td colspan="4">Comparison result acquired from the weighing sequence is shown in hexadecimal.</td> </tr> <tr> <td colspan="8"></td> <td colspan="4">Zero range</td> </tr> <tr> <td colspan="8"></td> <td colspan="4">Under (Hi-Hi)</td> </tr> <tr> <td colspan="8"></td> <td colspan="4">Over (Hi)</td> </tr> <tr> <td colspan="8"></td> <td colspan="4">Full Flow (Go)</td> </tr> <tr> <td colspan="8"></td> <td colspan="4">Medium Flow (Lo)</td> </tr> <tr> <td colspan="8"></td> <td colspan="4">Dribble Flow (Lo-Lo)</td> </tr> <tr> <td colspan="8"></td> <td colspan="4">Discharge gate open</td> </tr> <tr> <td colspan="8"></td> <td colspan="4">Batch finish</td> </tr> </table>											0	0	1	0	1	1	0	0	Comparison result acquired from the weighing sequence is shown in hexadecimal.												Zero range												Under (Hi-Hi)												Over (Hi)												Full Flow (Go)												Medium Flow (Lo)												Dribble Flow (Lo-Lo)												Discharge gate open												Batch finish			
0	0	1	0	1	1	0	0	Comparison result acquired from the weighing sequence is shown in hexadecimal.																																																																																																														
								Zero range																																																																																																														
								Under (Hi-Hi)																																																																																																														
								Over (Hi)																																																																																																														
								Full Flow (Go)																																																																																																														
								Medium Flow (Lo)																																																																																																														
								Dribble Flow (Lo-Lo)																																																																																																														
								Discharge gate open																																																																																																														
								Batch finish																																																																																																														

Weighing data
 Weighing data is described in 6 digits (HEX) and no decimal point.
 (Example)
 999.9 kg ---> 00270F (HEX)
 -0.1 kg ---> FFFFFFF (HEX)

Note) Select 19200 bps when data is output in the Output-per-Sampling Form.

HOW TO USE THE COMMAND MODE

In the command mode, a "command" is transmitted from an external unit to the AD-4401, the AD-4401 operates in compliance with the command and responds with a result. When the command is not accepted due to an error (improper command or faulty data), a "negative acknowledgment" is made. The communication procedure differs depending on the command.

Command Name	Function	Com. Procedures
RW (Request Weight)	Reads the weight	B
RB (Req. Batch status)	Reads the weighing sequence status	B
RF (Request Final)	Reads the weighing/loading result	B
RT (Request Total)	Reads the accumulated weight and times	B
DT (Delete Total)	Clears the accumulated value	A
MG (Make Gross)	Displays the gross	A
MN (Make Net)	Displays the net	A
MZ (Make Zero)	Clears to zero	A
MT (Make Tare)	Subtracts the tare	A
CT (Clear Tare)	Clears the tare	A
BB (Begin Batch)	Starts batching	A
BD (Batch Discharged)	Starts discharging	A
HB (Halt Batch)	Emergency stop	A
SS (Set Setpoints)	Sets the setpoints	C
RS (Request Setpoint)	Reads the setpoints to be used.	B
RE (Read EEPROM)	Reads from the EEPROM. Note: Accepted only in the calibration mode	B
WE (Write EEPROM)	Writes to the EEPROM. Note: Accepted only in the calibration mode	C

* RE and WE commands are accepted only in the calibration mode. (Step 2 state in 5-2)

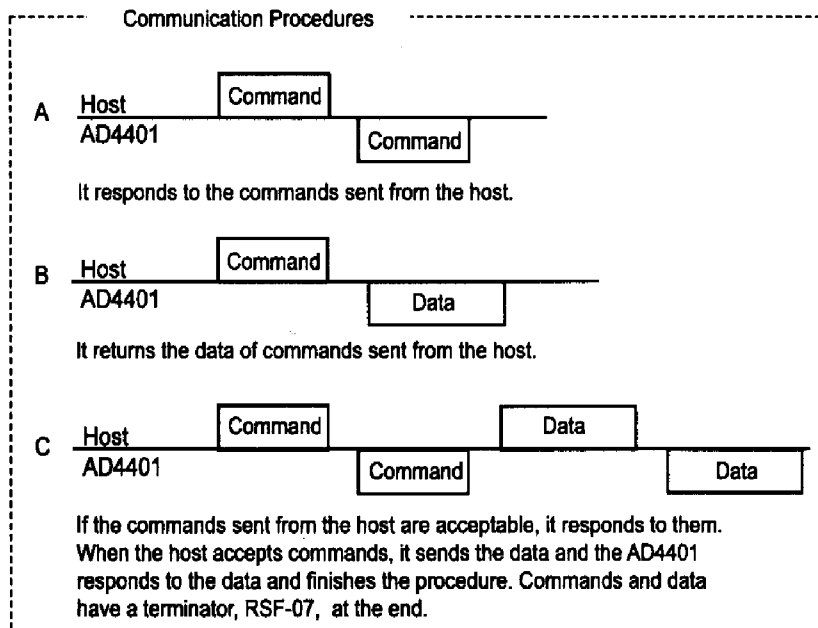

Type of Response	Description
Acknowledgment	Communication procedure A: Repeats the command as it is. Communication procedure B: Returns the data. Communication procedure C: Returns the command as it is and waits to receive the data.
Negative acknowledgment (Beyond condition): AD-4401 in non-receiving mode	IE
Negative acknowledgment (Beyond range): Data format correct, but value beyond allowable range	VE
Negative acknowledgment (Illegal command/data): Command or data format illegal	?E

Any response is made within 200 ms after receiving the command.

Command	Name	Function																					
RW	Request-Weight	Reads out the weight; The content of the response data is the same as that set with RSF-01. Same operation as when the manual print key is pressed. Data is sent in the "A&D standard format".																					
RB	Request-Batch-status	Reads out the weighing sequence status; The response data is sent in the "Output-per-Sampling Format". The weight output value is the net.																					
RF	Request-Final	Reads out the weighing (Batching) result; Outputs net weight when weighing completes. Data is sent in the "A&D standard format".																					
RT	Request-Total	Reads out the accumulated weight and times; Data is sent in the "Accumulation data format".																					
SS	Set Setpoints	Sets the setpoints; Writes 42-character for 7 setpoints altogether. Blanks are filled with 0. Each value is shown in 6 digit without decimal point. Data is sent in the following format.																					
		<table border="0" style="width: 100%; border-collapse: collapse;"> <tr> <td colspan="7" style="text-align: center;">Option</td> </tr> <tr> <td style="text-align: center;">Final</td> <td style="text-align: center;">Free Fall</td> <td style="text-align: center;">Preliminary</td> <td style="text-align: center;">Preliminary</td> <td style="text-align: center;">Over Limit</td> <td style="text-align: center;">Under Limit</td> <td style="text-align: center;">Zero Band</td> </tr> <tr> <td style="text-align: center;">1 2 3 4 5 6</td> <td style="text-align: center;">1 2 3 4 5 6</td> <td style="text-align: center;">1 2 3 4 5 6</td> <td style="text-align: center;">1 2 3 4 5 6</td> <td style="text-align: center;">1 2 3 4 5 6</td> <td style="text-align: center;">1 2 3 4 5 6</td> <td style="text-align: center;">1 2 3 4 5 6</td> </tr> </table>	Option							Final	Free Fall	Preliminary	Preliminary	Over Limit	Under Limit	Zero Band	1 2 3 4 5 6	1 2 3 4 5 6	1 2 3 4 5 6	1 2 3 4 5 6	1 2 3 4 5 6	1 2 3 4 5 6	1 2 3 4 5 6
	Option																						
	Final	Free Fall	Preliminary	Preliminary	Over Limit	Under Limit	Zero Band																
1 2 3 4 5 6	1 2 3 4 5 6	1 2 3 4 5 6	1 2 3 4 5 6	1 2 3 4 5 6	1 2 3 4 5 6	1 2 3 4 5 6																	
		<table border="0" style="width: 100%; border-collapse: collapse;"> <tr> <td style="text-align: center;">Target weight</td> <td style="text-align: center;">Hi-Hi limit</td> <td style="text-align: center;">Hi limit</td> <td style="text-align: center;">Lo limit</td> <td style="text-align: center;">Lo-Lo limit</td> <td style="text-align: center;">Not in use</td> <td style="text-align: center;">Zero Band</td> </tr> <tr> <td style="text-align: center;">1 2 3 4 5 6</td> <td style="text-align: center;">1 2 3 4 5 6</td> <td style="text-align: center;">1 2 3 4 5 6</td> <td style="text-align: center;">1 2 3 4 5 6</td> <td style="text-align: center;">1 2 3 4 5 6</td> <td style="text-align: center;">1 2 3 4 5 6</td> <td style="text-align: center;">1 2 3 4 5 6</td> </tr> </table>	Target weight	Hi-Hi limit	Hi limit	Lo limit	Lo-Lo limit	Not in use	Zero Band	1 2 3 4 5 6	1 2 3 4 5 6	1 2 3 4 5 6	1 2 3 4 5 6	1 2 3 4 5 6	1 2 3 4 5 6	1 2 3 4 5 6							
Target weight	Hi-Hi limit	Hi limit	Lo limit	Lo-Lo limit	Not in use	Zero Band																	
1 2 3 4 5 6	1 2 3 4 5 6	1 2 3 4 5 6	1 2 3 4 5 6	1 2 3 4 5 6	1 2 3 4 5 6	1 2 3 4 5 6																	
RS	Request-Setpoint	Reads out the Setpoints.; Same format as SS																					
RE	Read-EEPROM	Reads from the EEPROM; Reads the calibration or function data from the EEPROM. The data equivalent to 206 characters is returned in the ASCII code except the terminators. If this data is written to another AD-4401 with a "WE" command, calibration and function settings can be copied.																					
WE	Write-EEPROM	Writes to the EEPROM: Same format as the RE command																					

9-4 OP-05 SETPOINT UNIT

The OP-05 setpoint unit is a thumbwheel switch unit designed for setting the setpoints exclusive for Batch weighing and Loss-in-weighting use. By connecting this option to the AD-4401, each setpoint can be set with the thumbwheel switch on the panel or the BCD input. Since up to 10 of these optional units can be connected in series, the setpoints can be easily switched through an external unit.

Note

- When the minimum division is set to 10 or more, ten times the value set on the OP-05 will be used.
- When using this option, set the setpoint read mode SPF-01 to "2."

SPF-	Name	Default	Setting	
			Parameter	Description
01	Setpoint value read mode	0	0	Thumbwheel switch Unrequired mode
			1	5-digit mode
			2	16-digit mode

GENERAL SPECIFICATION

General Specification	
Power supply	11.5 to 25 V DC (Unrequired when external setting input or serial connection is not used)
Power consumption	3.5 W at maximum
Working temperature	-5 °C to 40 °C
Weight	Approx. 1 kg
Outer dimensions	192(W) x 118.6(D) x 57(H) mm (See the appearance drawing)
Setpoint parameter	Final (5 digits) / Free fall (3 digits) / Preliminary (4 digits)/ Overlimit (2 digits)/ Underlimit (2 digits) INT/EXT, switching by the slide switch on the front panel
Setpoint Values Which Can Be Set Externally	Final (5 digits. No input of 8 x 104) / Free fall (3 digits) / Preliminary (4 digits)

FRONT AND REAR PANEL

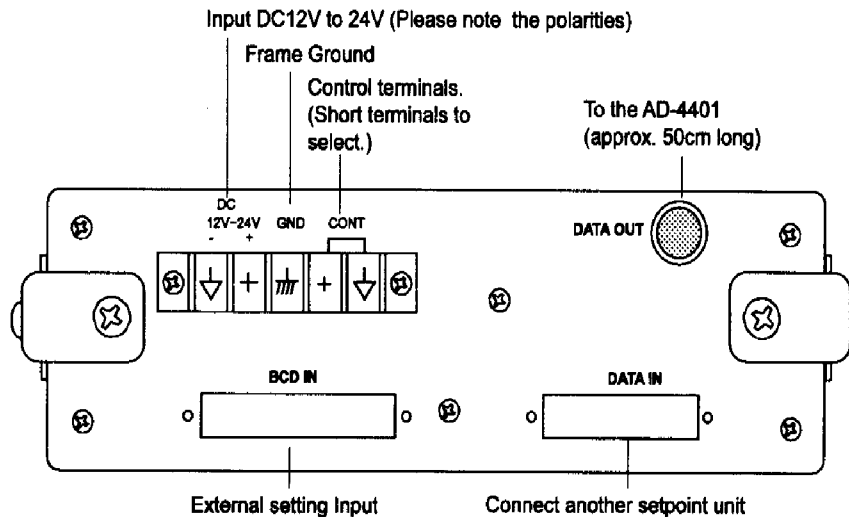
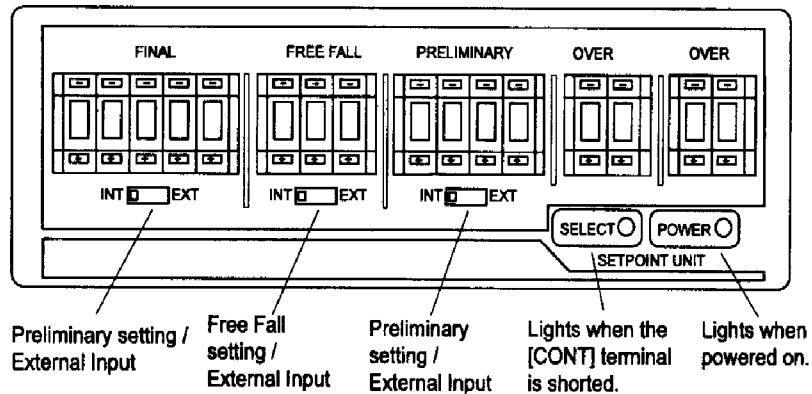

CONNECTION

When the power supply is not connected, this instrument can be set with the thumbwheel switch on the front panel. When this is done, set the INT/EXT selector switches to INT. When the BCD input or serial connection is required, connect the power supply and short the CONT terminal. This instrument is selected and the SELECT lamp is turned on. If the INT/EXT selector switch is set to INT, the thumbwheel switch will be selected, and if set to EXT, external setting input (BCD IN) will take effect.

By connecting two or more of these units in series and operating the CONT terminal from an external unit, you can select the required unit.

If the CONT terminal of the unit 2 is shorted in the figure below, the data set for 2 will be input. When this is done, if the other units are shorted simultaneously, the data for the unit closest to the AD-4401 will be input.

BCD IN

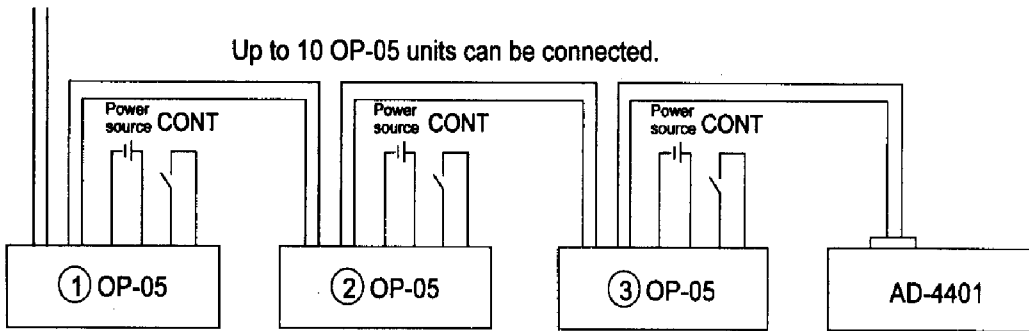

The CONT terminal is configured as shown in the figure below. It should be driven so that the rated current will be 50 mA or more and the terminal voltage at ON time will be 1 V or less.

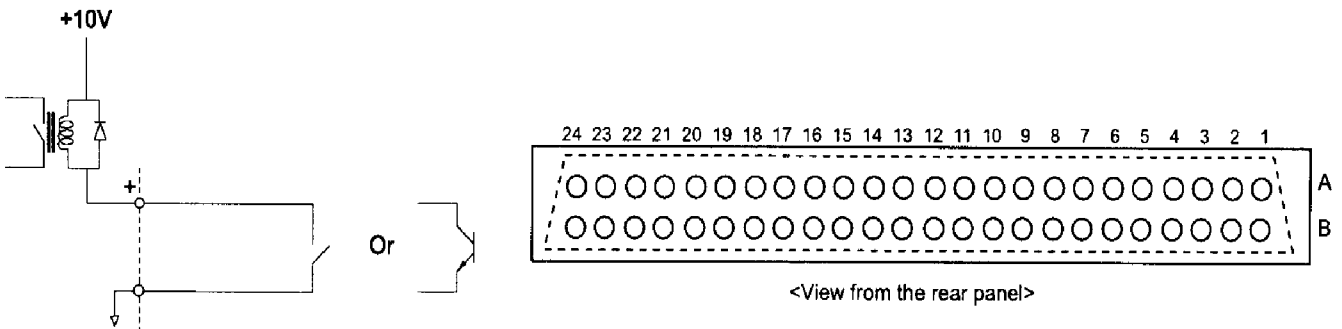

A	#	1	2	3	4	5	6	7	8	9	10	11	12	13	14	15	16	17	18	19	20	21	22	23	24
	Func.	Σ	1	2	4	8	1	2	4	8	1	2	4	8	1	2	4	8	1	2	4	1	2	4	8
		10 ⁰				10 ¹				10 ²				10 ³				10 ⁴				10 ⁰			
		Final																				Free Fall			
B	#	1	2	3	4	5	6	7	8	9	10	11	12	13	14	15	16	17	18	19	20	21	22	23	24
	Func.	1	2	4	8	1	2	4	8	1	2	4	8	1	2	4	8	1	2	4	8	1	2	4	8
		10 ¹				10 ²				10 ⁰				10 ¹				10 ²				10 ³			
		Free Fall								Preliminary															

USING THE EXTERNAL SETTING INPUT

External setting input for final, free fall, and preliminary is enabled by setting their respective INT/EXT selector switches to EXT. It is of BCD code and negative logic, and its level is about 10 V. Drive it with an open collector input or no-voltage (shorting type) contact input.

When using a relay, pay attention to the minimum applicable load.

OP-05 Inside

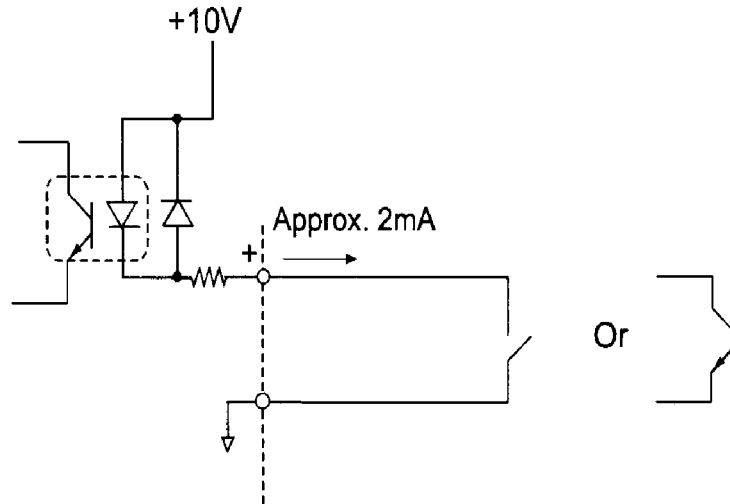

The following figure shows the connections used when using a PLC to set the final, free fall, and preliminary through the BCD input. Set the slide switch to EXT for the item you want to set from the external unit

BCD Input wiring

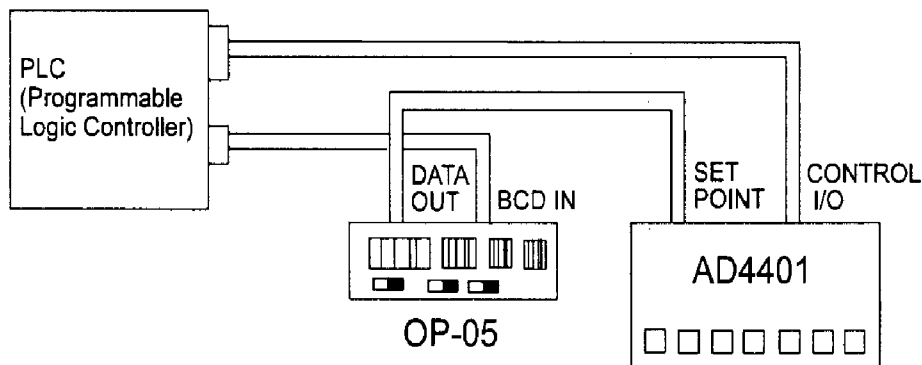

ACCESSORIES FOR OP-05 SETPOINT UNIT

Parts Name	Q'ty	A&D's Parts Number	Description
Fuse	1	FS-F7142-0.3A	F7142-0.3A, Sato Parts
Connector	1	J1-361J048-AG	FCN361J048-AU (or AG), Fujitsu
Connector cover	1	J1-360C048-B	FCN360C048-B, Fujitsu

9-5 OP-07 ANALOG OUTPUT

The OP-07 analog output option is for sending the weight data to an analog input unit. The output is a 4 to 20 mA current output proportional to the display reading.

The output data is updated in synchronization with the display update.

ANF-	Name	Default	Setting	
			Parameter	Description
01	Output data	1	1	Same as display
			2	Gross
			3	Net
02	Weight value at 4 mA output	0	-999999 to 9999999	The position of decimal point is set in CALF-02.
03	Weight value at 20 mA output	16000		

Interface Specification

Current output	4 to 20 mA
Applicable load resistance	0 to 520 Ω
Resolution	Approximately 1 / 3000
Non-linearity	+/- 0.1% F.S or less
Temperature coefficient	Zero point: +/- 0.02 %FS/ °C or less
	Sensitivity: +/- 0.02 %FS/ °C or less

SETTING METHOD

Set the weight value at a 4 mA output point in ANF-02 and that at a 20 mA output point in ANF-03, ignoring the unit of weight.

<Setting Example>

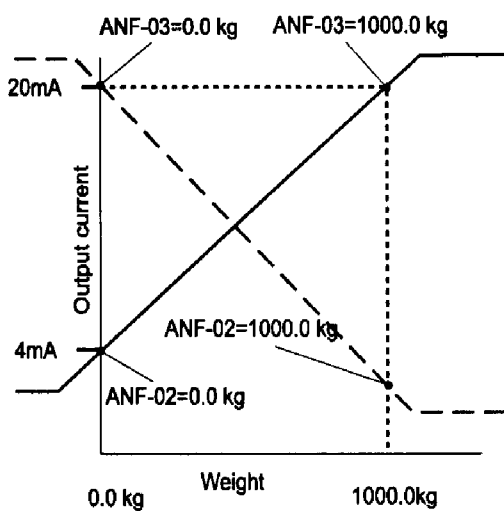

Outputting 4 mA at 0.0 kg and 20 mA at 1,000.0 kg. (Full line in the figure at the left)

ANF-02 = 0.0 kg
ANF-03 = 1000.0 kg

Outputting 20 mA at 0.0 kg and 4 mA at 1,000.0 kg. (Dotted line in the figure at the left)

ANF-02 = 1000.0 kg
ANF-03 = 0.0 kg

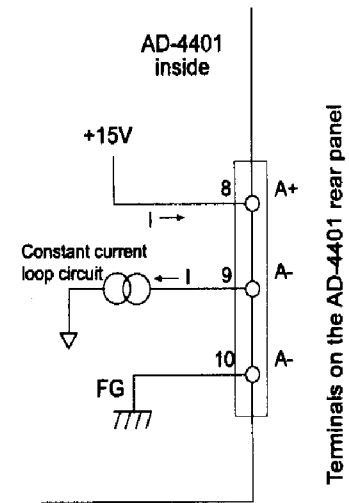



CHAPTER 10 MAINTENANCE

10-1 CHECK MODE

ENTERING CHECK MODE

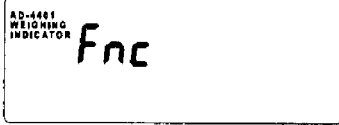
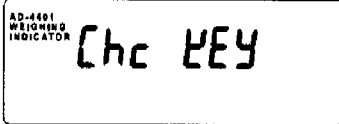
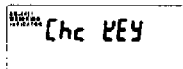
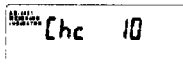
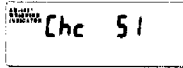
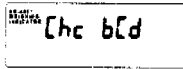
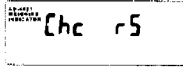
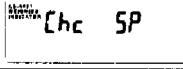
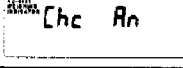
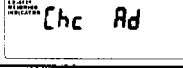
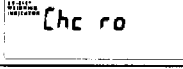
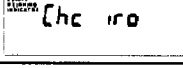
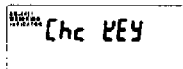
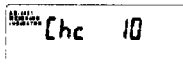
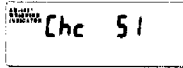
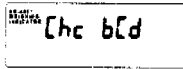
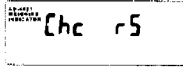
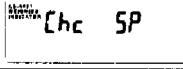
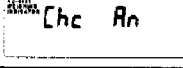
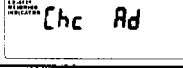
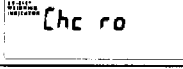
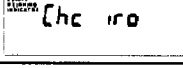
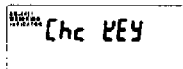
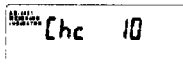
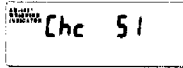
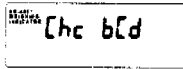
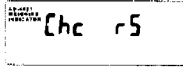
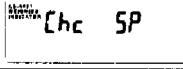
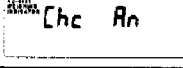
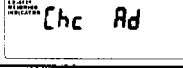
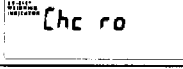
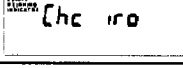
The check mode is intended to check the operations of the indicator, key switches, and external input/output.

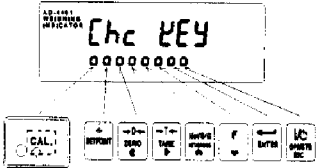
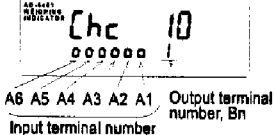
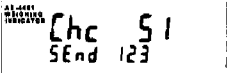
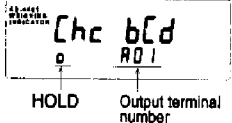
<p>Step 1</p>	<p>With the [ENTER] key pressed and held, press the [SETPOINT] key. "Fnc" is displayed to indicate that the indicator is entering the general function mode. Release both keys. Note: When entering the function mode is not wanted, press the [ESC] key. The indicator will return to the normal mode.</p>																																		
<p>Step 2</p>	<p>With the [ZERO] key pressed and held, press the [ENTER] key. The indicator will enter the check mode. "Chc key" is displayed and the cursor appears at the right end. Release both keys.</p>																																		
<p>Step 3</p>	<p>Using the [^] and [v] keys, select the desired check item. Select the desired check item and press the [ENTER] key. The indicator will enter the check mode for the selected item. To exit each check mode, press the [ESC] key.</p>	<table border="1"> <thead> <tr> <th>Check item</th> <th>Symbol</th> <th>Display</th> </tr> </thead> <tbody> <tr> <td>Key switch</td> <td>KEY</td> <td></td> </tr> <tr> <td>Control I/O</td> <td>IO</td> <td></td> </tr> <tr> <td>Standard serial output</td> <td>SI</td> <td></td> </tr> <tr> <td>BCD output (OP-01)</td> <td>BCD</td> <td></td> </tr> <tr> <td>RS-422(OP-03)/485(OP-04) I/O</td> <td>RS</td> <td></td> </tr> <tr> <td>Setpoint input (OP-05)</td> <td>SP</td> <td></td> </tr> <tr> <td>Analog output (OP-07)</td> <td>AN</td> <td></td> </tr> <tr> <td>A/D conversion (Load cell)</td> <td>AD</td> <td></td> </tr> <tr> <td>ROM version</td> <td>RO</td> <td></td> </tr> <tr> <td>CPU version</td> <td>IRO</td> <td></td> </tr> </tbody> </table>	Check item	Symbol	Display	Key switch	KEY		Control I/O	IO		Standard serial output	SI		BCD output (OP-01)	BCD		RS-422(OP-03)/485(OP-04) I/O	RS		Setpoint input (OP-05)	SP		Analog output (OP-07)	AN		A/D conversion (Load cell)	AD		ROM version	RO		CPU version	IRO	
Check item	Symbol	Display																																	
Key switch	KEY																																		
Control I/O	IO																																		
Standard serial output	SI																																		
BCD output (OP-01)	BCD																																		
RS-422(OP-03)/485(OP-04) I/O	RS																																		
Setpoint input (OP-05)	SP																																		
Analog output (OP-07)	AN																																		
A/D conversion (Load cell)	AD																																		
ROM version	RO																																		
CPU version	IRO																																		

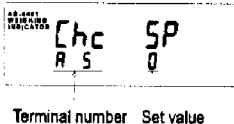
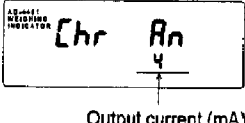
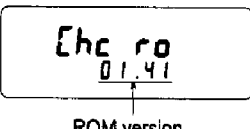
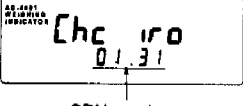
Item checked	Checking procedures	Display	
Key Switches	(O) Mark of the pressed key moves upward.		
Control I/O	<Input terminal number> (O) Mark of the ON-terminal moves upward. <Output terminal number> The terminal of the displayed number is on.		
Standard Serial Output	Pressing the [ENTER] key sends "1 2 3 <CR><LF>" at the baud rate set in the general function setting.		
OP-01 BCD	<Hold> (O) Mark moves upward when "Hold" is on. <Output terminal number> The terminal of the displayed number is on.		
OP-03 (RS-422/-485), OP-04 (RS-232C)	Pressing the [ENTER] key sends "1 2 3" based on setting made in the general functions. If the same data as the sent data is received, "PASS" will be displayed.		
Setpoints and OP-05 Setpoint Unit	<Terminal number> The number of COMMON terminal of the digit to be read is shown. <Set value> The value of the digit to be read is shown.		
OP-07 Analog Output	A current value (mA) being output is displayed. The current value can be changed with the [^] or [v] key.		
A/D Converter	A load cell signal value being input is displayed in the unit of mV/V. When this value is within a range of 0 to 2 mV/V with no load, it is likely that the load cell is damaged or it is connected improperly. Since an offset can be added to an A/D input, using the [^] or [v], the A/D converter can be checked for operations without applying a load to the load cell.		
	Procedure	Problem	Cause
	1	With +SIG and -SIG Load Cell terminals shorted, 0.0 mV/V is not displayed.	Load Cell excitation voltage or output voltage is incorrect, or Load Cell is wired incorrectly.
	2	When not loaded, the displayed value is out of a range of 0.0 mV/V to 2.0 mV/V.	Damaged Load Cell
	3	When loaded, the displayed value is smaller than that of procedure 2, or larger than 3.2 mV/V.	Load Cell is wired incorrectly, or incorrect rate of Load Cell.
4	* When the [^] or [v], key pressed, the displayed value does not increase.	Load Cell is incorrectly wired.	
* Note the value increase for future reference.			
ROM version	ROM version is displayed.		
CPU Version	CPU version is displayed.		

10-2 INITIALIZATION

Initialization is the operation to return the contents of the RAM and EEPROM to the initial factory values. There are three kinds of initialization modes, depending upon their ranges.

RAM initialization mode	Initializes the RAM only. Since the zero compensation value, tare value, setpoint, accumulated weight, and accumulated times are stored in the RAM, they are all cleared to zero.
General function initialization mode	Initializes both the RAM and the general function settings stored in the EEPROM.
All data initialization mode	Initializes the RAM and all data stored in the EEPROM (the general function settings, calibration related data) Since the calibration related data is also initialized, you must perform calibration again.

RAM INITIALIZATION MODE

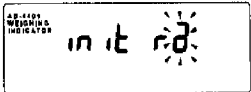
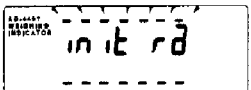
Step 1	Turn off the power. With the [SETPOINT] key pressed and held, turn on the power. All display digits are illuminated, and then, "init ra" is displayed.	
Step 2	Press the [ENTER] key. The indicator enters the RAM initialization mode. The "-" marks appear above and below the upper and lower display sections to prompt you for confirmation. When you want to initialize, continue pressing the [ENTER] key for 3 seconds or more. When you have entered this mode by mistake, do not hold the [ENTER] key, press the [ESC] key to exit.	

GENERAL FUNCTION INITIALIZATION MODE

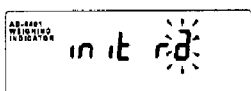
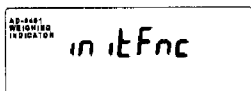
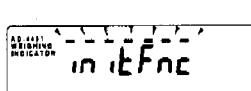
Step 1	Turn off the power. With the [SETPOINT] key pressed and held, turn on the power. All display digits are illuminated, and then, "init ra" is displayed.	
Step 2	Press the [^] key. "initFnc" is displayed.	
Step 3	Press the [ENTER] key. The indicator enters the general function initialization mode. The "-" marks appear above and below the upper and lower display sections to prompt you for confirmation. When you want to initialize, continue pressing the [ENTER] key for 3 seconds or more. When you have entered this mode by mistake, do not hold the [ENTER] key, press the [ESC] key to exit.	

ALL DATA INITIALIZATION MODE (Enter the All Data Initialization Mode from the calibration mode.)

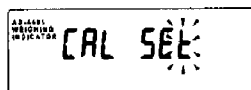
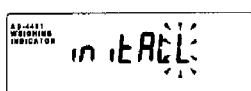
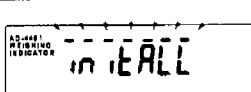
Step 1	Remove the cover from the calibration switch located at the lower left of the front panel and press the [CAL] key (found inside). "CAL" is displayed to inform you that the indicator is entering the calibration mode.	
Step 2	Press the [ENTER] key. Now, the indicator enters the calibration mode and "CAL SET" is displayed. The right most digit starts blinking.	
Step 3	Press the [v] key. "init ALL" is displayed	
Step 4	Press the [ENTER] key. The indicator enters the all data initialization mode. The "-" marks appear above and below the upper and lower display sections to prompt you for confirmation. When you want to initialize, continue pressing the [ENTER] key for 3 seconds or more. When you have entered this mode by mistake, do not hold the [ENTER] key, press the [ESC] key to exit.	

CHAPTER 11 SETTING LISTS

Use the settings list as a quick reference for maintenance of your AD-4401. When consulting with your A & D representative, let them know the user set values.

11-1 GENERAL FUNCTIONS

BASIC FUNCTIONS

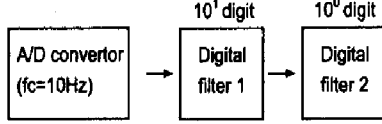
FNCF-	Name	User's	Default	Setting		
				Parameter	Description	
01	Key switch disable		00000000	00000000 to 11111111	0: Not disable 1: Disables	Each bit corresponding to the relevant key
02	Capabilities of [F] Key		0	0 to 8	0: None 1: Print command for manual print 2: Hold 3: * Batch Start 4: * Emergency stop 5: Clear to zero 6: Clear tare 7: Clear accumulation 8: lb-kg conv.(USA ver.)	* : Denotes exclusive for Normal batching mode.
03	Display Rewrite Rate		1	1 to 3	1: 20 times/sec 2: 10 times/sec 3: 5 times/sec.	
04	Display Content of Subdisplay Section		0	0 to 6	0: None 1: Gross 2: Net 3: Tare 4: Final value (Target weight) 5: Accumulated weight 6: Accumulated count	Paste the accessory label to the front panel in compliance with the display content.
05	" <input type="checkbox"/> " status display Capability		0	0 to 2	0: None 1: * discharging 2: Zero tracking	"Discharging" is exclusively intended for normal batching (built-in automatic program mode).
06	Digital Filter.		48	00 to 79	Series connection of two digital filters. Value of each digit and cutoff frequency 0: None 1: 11.0 Hz 2: 8.0 Hz 3: 5.6 Hz 4: 4.0 Hz 5: 2.8 Hz 6: 2.0 Hz 7: 1.4 Hz 8: 1.0 Hz 9: 0.7 Hz	The digital filter is designed to suppress dispersion of a load cell output signal. Two of them are connected in series as shown below.  Low frequency components which cannot be covered only by setting of the digital filters can be dealt with by equivalently lowering the cutoff frequency of the digital filters at FNCF-07.
07	Sampling frequency dividing ratio.		1	1 to 10	Lower the cutoff frequency of the digital filters equivalently by reducing the specified sampling times to one.	
08	Hold operation		1	1 to 2	1: Normal hold 2: Peak hold	During peak hold, the positive peak of the weight value is held.
09	Comparison stop at hold		0	0 to 1	0: No 1: Yes	In case of sequential batching, do not set "1" because the weighing sequence stops when comparison stops.

WEIGHING SEQUENCE FUNCTIONS

SQF-	Name	User's	Default	Setting		
				Parameter	Description	
01	Selection of comparison weight		1	1	Internal count	
				2	Display count	
02	Automatic accumulation		0	0	No Automatic accumulation	
				1	Accumulates only acceptable weight	
				2	Accumulates all values	
03	Automatic free fall compensation		0	0	No automatic free fall compensation	
				1	Moving average of last four times.	
				2	Fuzzy automatic free fall compensation	
04	Automatic free fall effective width.		0	0 to 99999999	Automatic free fall compensation is made if a loaded weight is within the final +/- automatic free fall effective width.	
05	Unstable Dribble Flow Timer		3.0	0.0 to 25.5 (In step of 0.1 second)	If Flow-time is shorter than the setting, the preset Free Fall is applied to the weighing instead of the Auto-Free-Fall compensation.	
06	Overlimit/underlimit operation		2	1	Real-time comparison	
				2	Synchronized with Batch Finish Output	
07	Stability at judgment		1	0	Unrequired	
				1	Required	
08	Maximum number of supplementary flow times		0	0 to 255	0: Unused	
					Non-0: Set times	
09	Batch start wait timer		0.0			
10	Full-flow comparator inhibitor timer		0.0	0.0 to 25.5 (In step of 0.1 second)	N/A	Only normal batching (built-in automatic program mode) is effective
11	Medium-flow comparator inhibitor timer		0.0			Only effective in Built-In-Automatic Program mode.

SQF-	Name	User's	Default	Setting			
				Parameter	Description		
12	Dribble-flow comparator inhibitor timer		0.0	0.0 to 25.5 (In step of 0.1 second)	N/A	Only effective in Built-In-Automatic Program mode.	
13	Judgment wait timer		0.1		0:Until next Batch Start		
14	Batch Finish output width		0.0		Non-0: Set time		
15	Batch monitoring timer		0	0.0 to 25.5 (In step of 1 second)	0: Unused		
					Non-0: Set time		
16	Supplementary Flow open timer		0.10	0.0 to 25.5 (In step of 0.01 second)	Intentionally blank		
17	Supplementary Flow close timer		0.1	0.0 to 25.5 (In step of 0.1 second)			
18	Discharging start wait timer		0.0				
19	Discharging valve close wait timer		0.1				Only normal batching (built-in automatic program mode) is effective
20	Discharging time monitor timer		0	0.0 to 25.5 (In step of 1 second)	0: Unused		
					Non-0: Set time		
21	Add the final to zero band setting		0	0	Does not add the final	Only loss-in-weight is effective	
				1	Adds the final		
22	Add the final to full setting		0	0	Does not add the final		
				1	Adds the final		

CONTROL I/O INPUT FUNCTIONS

INF-01: Capability of Input Terminal A1					
INF-02: Capability of Input Terminal A2					
INF-03: Capability of Input Terminal A3					
INF-04: Capability of Input Terminal A4					
INF-05: Capability of Input Terminal A5					
INF-06: Capability of Input Terminal A6					
Default					
Setting					
Parameter					
Description					
0 No capability					
1 Zero					
2 Tare					
3 Batch start					
4 Emergency stop					
5 Discharge start					
6 Key enable					
7 Automatic free fall command					
8 Disable thumbwheel switch read					
9 Clear tare					
10 Accumulation command					
11 Cancel previous accumulation					
12 Clear accumulation					
13 Hold					
14 Print command for manual print					
User's settings					

CONTROL I/O OUTPUT FUNCTIONS

OUTF-01: Capability of Output Terminal B1							
OUTF-02: Capability of Output Terminal B2							
OUTF-03: Capability of Output Terminal B3							
OUTF-04: Capability of Output Terminal B4							
OUTF-05: Capability of Output Terminal B5							
OUTF-06: Capability of Output Terminal B6							
OUTF-07: Capability of Output Terminal B7							
OUTF-08: Capability of Output Terminal B8							
Default							
Setting							
Parameter							
Description							
0 No capability							
1 Zero range							
2 Underlimit/ Hi-Hi							
3 Overlimit/Hi							
4 Full flow/ Full/ Go							
5 Medium flow/ Lo							
6 Dribble flow/ Lo-Lo							
7 Discharge							
8 Batch Finish							
9 Stability							
10 Online							
11 Weighing sequence running							
12 Weighing sequence error							
13 Input acknowledge							
14 Zero range error							
15 Weighing capacity overflow							
16 Low battery							
User's settings							

STANDARD SERIAL OUTPUT FUNCTIONS

SIF-	Name	User's	Setting			
			Default	Parameter	Description	
01	Output Data		1	1	Displayed weight	A & D standard format
				2	Gross	
				3	Net	
				4	Tare	
				5	Gross/Net/Tare	Accumulation data format
				6	Accumulated weight	
				7	Accumulated counts	
				8	Accumulated weight /Accumulated counts	
02	Data transmitting mode		1	1	Stream mode	
				2	Auto-Print mode	
				3	Manual-Print mode	
03	Baud rate		2	1	600 bps	
				2	2400 bps	

OP-01 BCD PARALLEL OUTPUT FUNCTIONS

BCDF-	Name	User's	Default	Setting	
				Parameter	Description
01	Output data		1	1	Displayed weight
				2	Gross
				3	Net
				4	Tare
02	Data transfer mode		1	1	Stream
				2	Auto print
				3	Manual print
03	Data output logic		2	1	Positive logic
				2	Negative logic
04	Strobe output logic		2	1	Positive logic
				2	Negative logic

OP-03 RS-422 / OP-04 RS-232C FUNCTIONS

RSF-	Name	User's	Default	Setting		
				Parameter	Description	
01	Output data		1	1	Displayed weight	A&D standard format
				2	Gross	
				3	Net	
				4	Tare	
				5	Gross/Net/Tare	Accumulated data format
				6	Accumulated weight	
				7	Accumulated counts	
				8	Accumulated weight/ Accumulated counts	
02	Data transfer mode		1	1	Stream	Set to 9600 bps or less at the time of output per sampling.
				2	Auto print	
				3	Manual print	
				4	Command	
				5	Comparison data + Gross ; Output per sampling	
				6	Comparison data + Net; Output per sampling	
03	Baud rate		5	1	600 bps	
				2	1200 bps	
				3	2400 bps	
				4	4800 bps	
				5	9600 bps	
				6	19200 bps	
04	Parity		2	0	None	
				1	Odd	
				2	Even	
05	Character bit length		7	7	7 bits	
				8	8 bits	
06	Stop bit length		1	1	1 bit	
				2	2 bit	
07	Terminator		2	1	CR	
				2	CR LF	
08	RS-422/RS-485 switching		1	1	RS-422	This setting is invalid when the RS-232C is used.
				2	RS-485	
09	Address number		0	0	Without address capability 01-99: With address capability	Set to 0 in case of the RS-232C.

OP-05 SETPOINT FUNCTIONS

SPF-	Name	User's	Default	Setting	
				Parameter	Description
01	Setpoint value read mode		0	0	Thumbwheel switch Unrequired mode
				1	5-digit mode
				2	16-digit mode

OP-07 ANALOG OUTPUT FUNCTIONS

ANF-	Name	User's	Default	Setting	
				Parameter	Description
01	Output data		1	1	Same as display
				2	Gross
				3	Net
02	Weight value at 4 mA output		0	-999999 to 999999	The position of decimal point is set in CALF-02.
03	Weight value at 20 mA output		16000		

11-2 CALIBRATION RELATED FUNCTIONS

CALF-	Name	User's	Setting			
			Default	Parameter	Description	
01	Weighing Unit		2	0	None	
				1	g (International version)	
				2	kg (International version and USA version)	
				3	t (International version)	
				4	lb (USA version)	
02	Decimal Point Position		0	0	None	12345
				1	10 ¹	1234.5
				2	10 ²	123.45
				3	10 ³	12.345
				4	10 ⁴	1.2345
03	Minimum Division		1	1, 2, 5, 10, 20, or 50	Minimum division(increment) for the weight value. Input 1,2, 5, 10, 20, or 50(decimal point ignored).	
04	Capacity		16000	0 to 800000	Capacity of the weighing. Weighing is allowed up to this setting + 9D(9 divisions). A weight value beyond this limit is an overflow and not displayed.	
05	Zero Range		2	0 to 30	A range of accepting "zero" from the [ZERO] key or Control I/O. Represented in terms of percent(&) with respect to the weighing capacity, centering around the zero calibrated point in calibration. If this is set to 2, "zero" can be accepted within a range of the zero calibrated point +/- 2 %.	
06	Zero Tracking Time		0.0	0.0 to 5.0	Zero tracking is performed in combination with CALF-07 Zero Tracking Width. It is not performed when set to 0.0. Its unit is seconds	
07	Zero Tracking Width		0	0 to 9	Zero tracking is performed in combination with CALF-06 Zero Tracking Time. It is not performed when set to 0. Its least input increment is 1/2D. (The width for setting of 1 is equivalent to 1/2 of the minimum graduation)	
08	Motion Detect Time		1.0	0.0 to 5.0	Motion is detected in combination with CALF-09 Motion Detection Width. It is not detected when set to 0. Its unit is seconds.	
09	Motion Detect Range		2	0 to 9	Motion is detected in combination with CALF-08 Motion Detection Time. Its least input increment is 1D. (The range for setting of 1 is equivalent to the minimum division)	
10*	Tare and Zero at Unstable Weight Value		1	0	"Tare" is not accepted when the weight value is unstable.	
				1	"Tare" is accepted even if the weight value is unstable.	
11*	Tare at Negative gross		1	0	"Tare" is not accepted when the gross weight is negative.	
				1	"Tare" is accepted even if the gross weight is negative.	

Not available on the USA version.

CALF-	Name	User's	Setting				
			Default	Parameter	Description		
12	Standard Serial Output; Output When Weight Value Is Overflowing or Unstable		1	0	Does not output when the weight value is overflowing or unstable		
				1			
13	RS-232C/-422/-485; Output When Weight Value Is Overflowing or Unstable		1	0	Does not output when the weight value is overflowing or unstable.		
				1			
14	Weighing Mode		3	1	Batch Weighing	For the hopper scale use	
				2			
				3			
				4			
				5	Check-Weighing		For the platform scale use
				6			
				7			
				8			
15	Zero Input Voltage		0.000000	0.000000 to 2.200000	Input Voltage (mV/V) from the Load Cell at "Zero", which is determined in "Zero Calibration" with weights.		
16	Span Input Voltage (Capacity to zero)		3.200000	0.000000 to 3.200000	Input Voltage (mV/V) from the Load Cell at "Span", which means the difference between Capacity and Zero. The voltage is determined in "Span Calibration" with weights.		
17	Weight against Span Input Voltage		16000	0 to 800000 (decimal point ignored)	When "Digital-Calibration", calibration not using weights, is performed, CALF-15 and CALF-16 also have to be done. This setting will be changed to Capacity (CAL-04) if "CAL Set" is done.		

APPENDIX DIMENSIONS

AD-4401

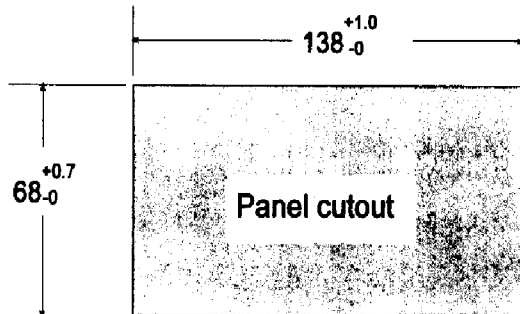
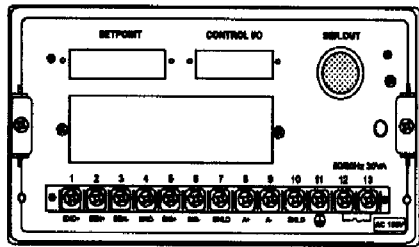
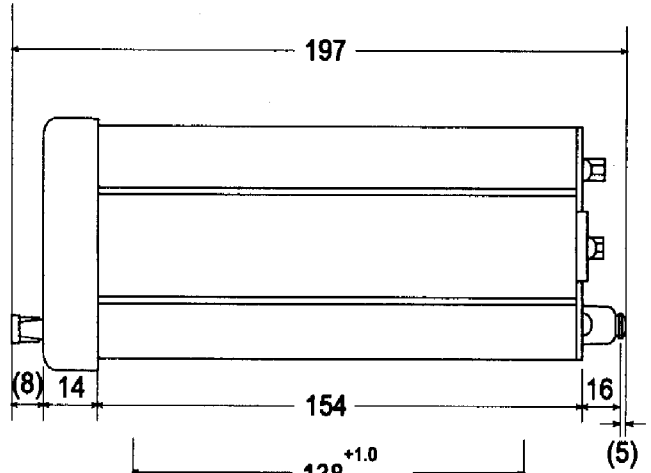
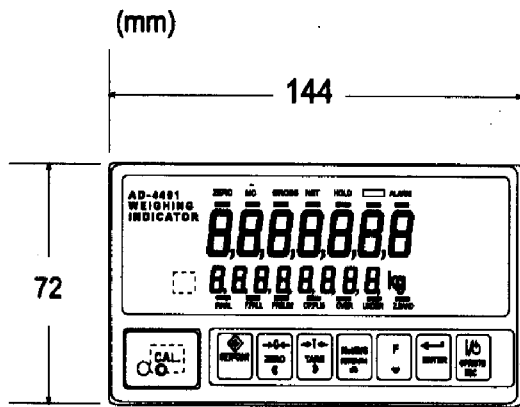

OP-05

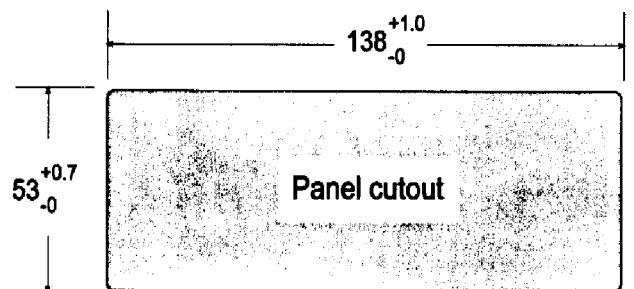
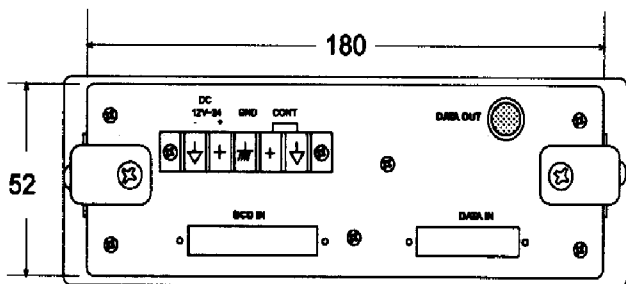
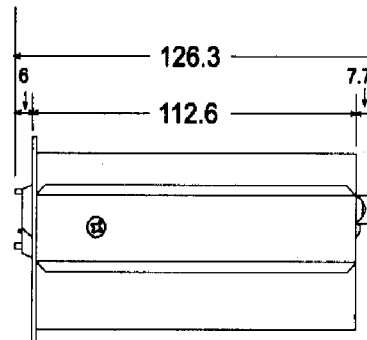
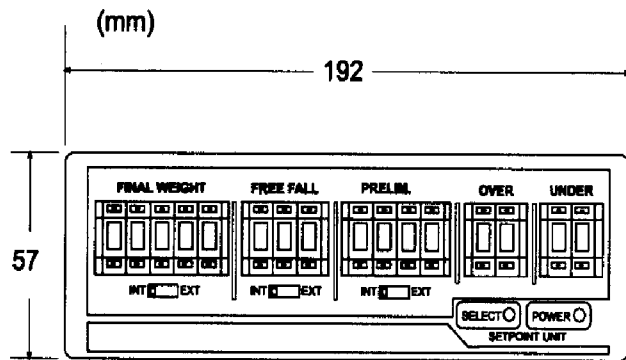



A&D Company, Limited

3-23-14 Higasi-Ikebukuro, Toshima-Ku, Tokyo 170 JAPAN
Telephone: [81] (03) 5391-6132 Fax: [81] (03) 5391-6148

A&D ENGINEERING, INC

1555 McCandless Drive, Milpitas, CA. 95035 U.S.A
Telephone: [1] (408) 263-5333 Fax [1] (408) 263-0199

A&D INSTRUMENTS LTD

Abingdon Science Park, Abingdon, Oxford OX14 3YS ENGLAND
Telephone: [44] (0235) 550420 Fax [44] (0235)550485

(German Sales Office)

Genfer Strasse 6, Niedereschbach 60437 Frankfurt Main 50 GERMANY
Telephone: [49] (069) 507-1017 Fax [49] (069) 507-2054

A&D MERCURY PTY. LTD.

32 Dew Street, Thebarton, South Australia 5031 AUSTRALIA
Telephone: [61] (08) 352-3033 Fax [61] (08) 352-7409

A&D KOREA Limited

Seongmi Building 2/3F, 740-18 Panpo-1dong, Seocho-ku, Seoul, KOREA
Telephone: [82] (02) 517-4101 Fax [82] (02) 546-4264